

TOOLS, FASTENERS & SEWER EQUIPMENT

HYDRAULIC DRAIN FLUSHERS

DRAIN KING

PART #	DESCRIPTION
40811010	3/4" & 1" Drains
40811012	1" to 2" Drains
40811007	1-1/2" to 3" Drains
40811002	3" to 4" Drains
40811003	3" to 6" Drains
40811011	4" to 6" Drains
75971214	6" to 10" Drains



DRAINJET

PART #	DESCRIPTION
40811008	1-1/4" to 2" Drains
40811009	2" to 2-1/2" Drains
40811005	2-3/4" to 3" Drains
40811004	3-1/2" to 4" Drains
40811006	4-1/2" to 6" Drains

- Expands under water pressure
- Built-in backflow preventer
- Attaches to garden hose
- Easy and economical
- Ecologically safe, no chemicals needed



FORCE CUPS

ITEM	PART #	DESCRIPTION
1	20100002	4" Dia. cup with 9" handle
2	20100160	4" Dia. high neck cup w/ 24" handle
3	75160100	5" Dia. cup with 18" handle (not shown)
4	20100161	6" Dia. cup with 18" handle
5	75720160	6" Dia. cup with 21" handle
6	20100057	Samson Heavy Duty Force Cup w/ 21" handle
7	20100162	Drain Pump Heavy Duty Force Cup w/ 21" handle
8	20100061	Hand held mini plunger, 2"
9	20100010	Master Plumber
10	20100064	"Toilaflex" Heavy Duty Force Cup
11	20100059	Bull Dog Force Cup

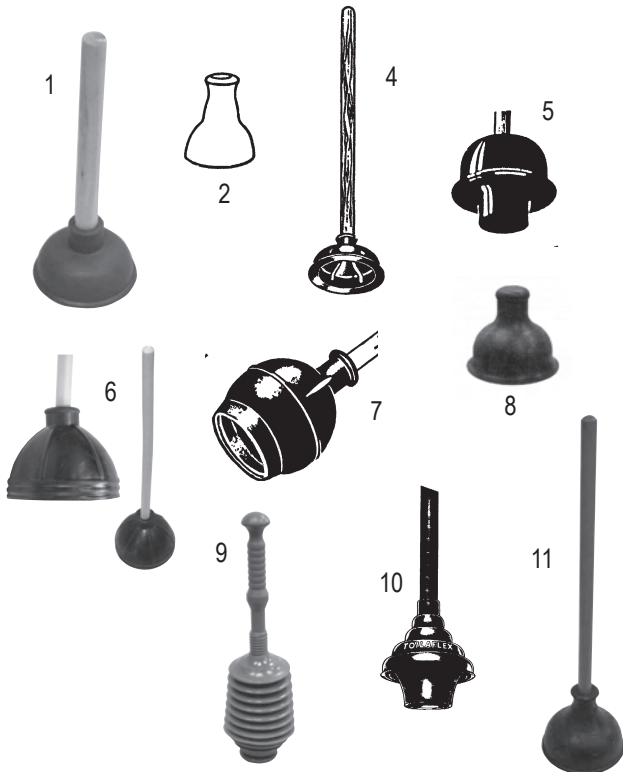

HYDRAULIC DRAIN FLUSHER ACCESSORIES

PART #	DESCRIPTION
75971222	Drain adapter
20100063	All in one Drain Kit for 1-1/2" to 3" Drains. Includes hose & faucet aerator adapter
75971206	10' hose with aerator adapter

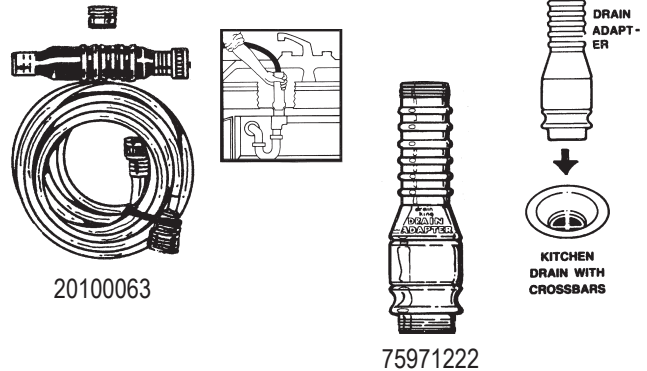

TMS "DRIP PROOF" PLUNGER BAG

- 28" long by 7" wide
- Breathable mesh end
- Washable
- Nylon zipper
- Carrying handle



PART # 20100067

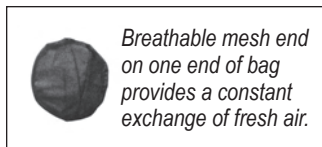

Breathable mesh end on one end of bag provides a constant exchange of fresh air.

*Plunger not included



TOTAL MAINTENANCE SOLUTIONS

HOUSTON
800/392-5066

ORLANDO
800/327-3022

GREENVILLE
800/476-2212

LOOK FOR US ON THE WEB AT: www.TMSSouth.com

TOOLS, FASTENERS & SEWER EQUIPMENT

CLOSET AUGERS

PART #	DESCRIPTION	PART #	DESCRIPTION
20100006	3 ft. Flexicore – regular head, 3/8	75361520	Replacement Head only – regular head
20100152	3 ft. Flexicore music wire – regular head	75361525	Replacement Head only – downhead
20100066	3 ft. with drop head	20100058	Urinal auger, 5/16
20100007	6 ft. Teletube Flexicore – downhead, 3/8	75361501	Economy closet auger
20100056	6 ft. Teletube Flexicore – regular head	20100058	Cable only for urinal auger, PART # 20100058
20100163	6 ft. Cable only Flexicore – regular head (For use on 20100056 auger)		

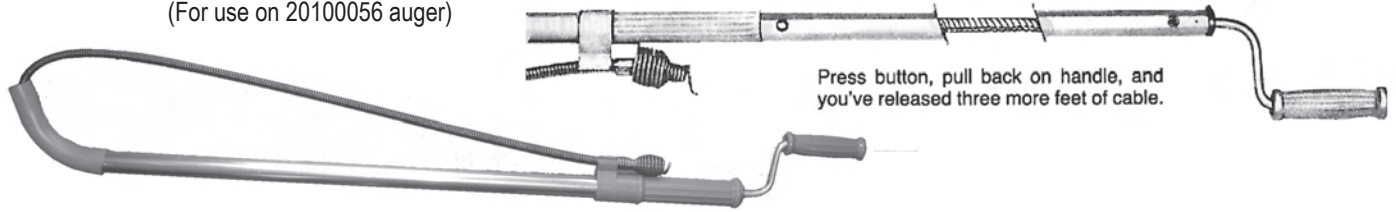
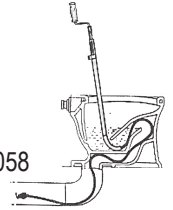

Press button, pull back on handle, and you've released three more feet of cable.

TMS "DRIP PROOF" AUGER BAG

- 46" long by 7" wide
- Breathable mesh end
- Washable
- Nylon zipper
- Carrying handle

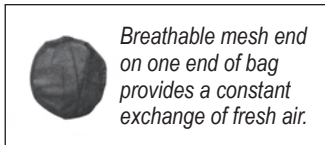

Breathable mesh end on one end of bag provides a constant exchange of fresh air.

PART # 20100068



*Auger not included

ECONOMY AUGER WITH ROTARY HANDLE

PART #	DESCRIPTION
75361108	1/4" X 25 ft. cable

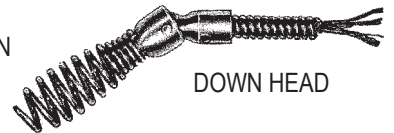

DOWN HEAD

FLEXICORE WIRE ROPE CENTER AUGERS

Comes with Rotary Handle.
For 1-1/4" thru 2" drain lines.



REGULAR HEAD

PART #	DESCRIPTION
75361102	3/8" X 25 ft. with Downhead
75361104	3/8" X 35 ft. with Downhead
75361106	3/8" X 50 ft. with Downhead

PLUMBER ONE

Environmentally safe, uses no acid or lye. One can unblocks up to 12 drains.



PART #	DESCRIPTION
75002002	3 piece starter set

PRESSURE PLUMBER

Instant drain opener. Ozone friendly, non-toxic.



PART #	DESCRIPTION
60800002	10.5 oz can

POWER PLUMBER CONDENSATE LINE CLEANER KIT

PART # 75006001

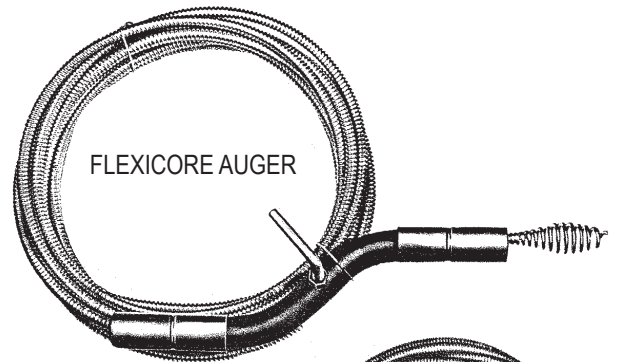

FLEXICORE AUGER

ECONOMY AUGER

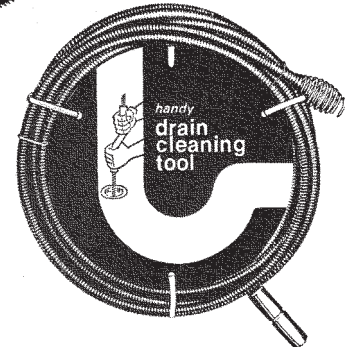

HOUSTON
800/392-5066

ORLANDO
800/327-3022

GREENVILLE
800/476-2212

LOOK FOR US ON THE WEB AT: www.TMSSouth.com

TOOLS, FASTENERS & SEWER EQUIPMENT

JET PLUNGER

Don't plunge it – JET PLUNGE IT!

- One way compressed air
- Hygienic system eliminates splashback
- Unique ergonomic design
- Anti-microbial storage catch-base

PART # 20100060

ALSO AVAILABLE:

Sink kit/small drain attachment

PART # 75164042



KINETIC WATER RAM

Kinetic water ram, complete with water supply hose, universal faucet adapter, caulking hose, 4" rubber cone, 5 rubber plugs plus carrying case.

PART # 20100063

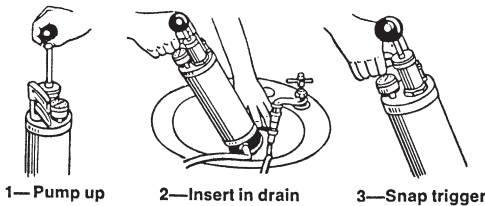
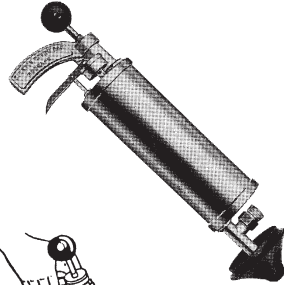

FLAT SEWER RODS

PART #	PIPE SIZE	DESCRIPTION
75361110	Small pipe	1/4" X 1/16" X 25 ft. w/ roller head
40811001	Small pipe	1/4" X 1/16" X 25 ft. w/ drop head
20100062	2" thru 4"	1/2" X 1/16" X 50 ft. w/ roller head
75361138	2" thru 4"	1/2" X 1/8" X 50 ft. w/ roller head
75361140	2" thru 4"	1/2" X 1/8" X 75 ft. w/ roller head
75361142	4" thru 6"	3/4" X 1/8" X 50 ft. w/ roller head
75361144	4" thru 6"	3/4" X 1/8" X 75 ft. w/ roller head

* Longer length Rods are available

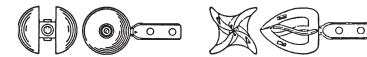
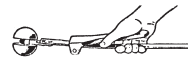
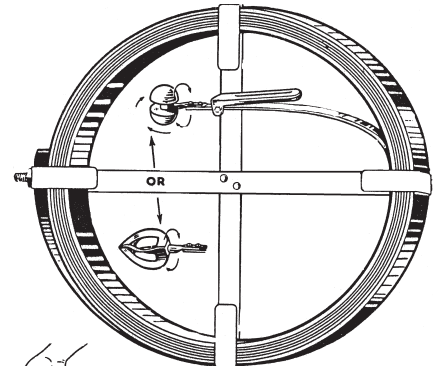

REVOLVING ROLLER & SPEAR HEAD



FLEXIBLE ROLLER & SPEAR HEAD

SNAKENTAINER

75361114

Cleans drain lines from 1-1/4" thru 2". Economical way to unstop small drain lines. Container has the capacity of 35 feet of 3/8" or 50 feet of smaller snakes.

PART#	DESCRIPTION
20100164	1/4" X 25 ft. cable with downhead
20100165	1/4" X 25 ft. cable with regular head
20100166	Handy Snakentainer only
75361114	Economy Drain Cleaner w/ 1/4" X 25 ft. cable

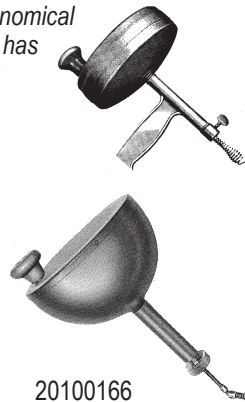

20100166

EXTRA PARTS FOR FLAT SEWER RODS

PART #	DESCRIPTION
20100167	Revolving roller head for 1/2" X 1/16" Rod
20100168	Revolving roller head for 1/2" X 1/8", 3/4" X 1/16" & 3/4" X 1/8" Rod
20100169	Revolving roller head for 1" X 1/8" or 1-1/4" X 1/8" Rod
20100170	Flexible roller head for 1/2" X 1/16" Rod
20100171	Flexible roller head for 1/2" X 1/8", 3/4" X 1/16" & 3/4" X 1/8" Rod
20100172	Revolving spear head for 1/2" X 1/16", 3/4" X 1/16" & 1/2" X 1/8" Rod
20100173	Flexible spear head for 1/2" X 1/16", 3/4" X 1/16" & 1/2" X 1/8" Rod
20100174	Flexible spear head for 3/4" X 1/8" & 1" X 1/8" Rod

WATER PUMP

36" pump with 72" discharge hose
PART # 20100077



PLUMBER'S AIR PUMP

Part # 20100078



"THE SUCK TUBE"

Part # 64100617



TOTAL MAINTENANCE SOLUTIONS

HOUSTON
800/392-5066

ORLANDO
800/327-3022

GREENVILLE
800/476-2212

LOOK FOR US ON THE WEB AT: www.TMSSouth.com

TOOLS, FASTENERS & SEWER EQUIPMENT

SECTIONAL SEWER RODS

1/4" X 6 foot sections of round oil tempered steel. Operates efficiently at 200 feet. Makes 90 degree bends in 4" and 6" sewer lines. Will not operate in traps. Sewer Rod unit consists of 17 rods (total 102 ft.), couplings, cutter set and rod frame. Additional Rods and Cutter set components are available. Use TMS PART # 75360120 for ordering the complete Sewer Rod unit.

Cutaway View of Galvanized Coupling

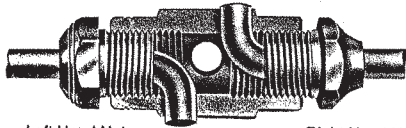

Left Hand Nut

Right Hand Nut

Sectional Rods assemble at right angles and cannot come apart in the line.

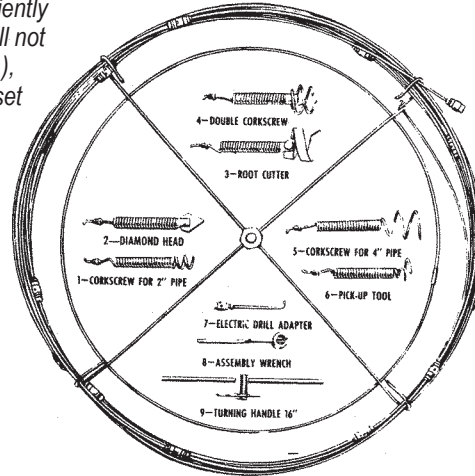

Attach desired tool and assemble 6 ft. sections while feeding rod to obstruction.

Engage turning handle on first coupling from the end, with rod under arm to balance operation. Turn into stoppage and pull out to release water.

GENERAL WIRE SPRING CO. GEN-EYE3

For in-line inspection and preventative maintenance of sewer and drain lines, septic tanks, heating and cooling ducts, crawl spaces, etc. Troubleshoot 1-1/2" though 12" lines. Durable stainless steel camera body protects it and a scratch resistant sapphire lens keeps pictures crystal clear. Specially designed spring and camera shape negotiates bends and slides smoothly through the line. 28 ultra bright LED's.



General Wire Spring Co.

SRECO FLEXIBLE TELEVISION INSPECTION SYSTEMS

Deluxe Video Inspection System with VCR Monitor

System Includes:

- Monitor with built in VCR, microphone, speaker and AC/DC adapter
- Heavy duty metal carrying case
- Push cable and portable reel with 100', 150' and 200' cable options
- Monitor cable
- Flexicam™ low lux mini-camera with red cluster LED lights
- "New Style" Flexlink cable to slide camera easily through pipe bends



CALL US FOR ADDITIONAL INFORMATION AND AVAILABLE SYSTEMS AND ACCESSORIES



TOTAL MAINTENANCE SOLUTIONS

HOUSTON
800/392-5066

ORLANDO
800/327-3022

GREENVILLE
800/476-2212

LOOK FOR US ON THE WEB AT: www.TMSSouth.com

TOOLS, FASTENERS & SEWER EQUIPMENT

GENERAL WIRE SPRING CUTTING HEADS



BORING GIMLET
For removing loose objects
PART # 20100039- 3/8" Cable



SIDE CUTTER BLADES
For cutting and scraping
PART # DESCRIPTION
20100038 3/8" Cable 1-1/4" drain
20100175 1/2", 5/8" & 3/4" Cable 2" drain
20100176 1/2", 5/8" & 3/4" Cable 3" drain
20100177 1/2", 5/8" & 3/4" Cable 4" drain



FEMALE CONNECTOR
PART # 75361034- 3/8" Cable
PART # 75361040- 1/2" Cable
PART # 75361043- 5/8" Cable
PART # 75361044- 3/4" Cable

MALE CONNECTOR
PART # 75361036- 3/8" Cable
PART # 75361038- 1/2" Cable
PART # 75361041- 5/8" Cable
PART # 75361042- 3/4" Cable



FLEXIBLE ARROW HEAD
For sharp turns in small lines
PART # 20100178- 3/8" Cable



SPEAR HEAD
A good starting tool to get water flowing
PART # 75361222- 5/8" or 3/4" Cable



HEAVY DUTY SIDE CUTTERS
Extra thick blades with beveled edges
PART # DESCRIPTION
75361018 5/8" or 3/4" Cable 3" drain
75361020 5/8" or 3/4" Cable 4" drain



DOWN HEAD BORING GIMLET
Leads cable down the line
PART # 20100040- 3/8" Cable



2" "U" CUTTER
For cutting and scraping
PART # 20100181- 1/2", 5/8" & 3/4" Cable



CORKSCREW RETRIEVING TOOL
For removing loose objects
PART # 20100184- 5/8" or 3/4" Cable



ALL-PURPOSE DOWN HEAD FITTING
Can be used with all standard Super-Vee cutters
PART # 20100179- 3/8" or 1/2" Cable



ROTARY SAW BLADES
For roots and other stoppages
PART # DESCRIPTION
20100182 1/2", 5/8" & 3/4" Cable 3" drain
20100183 1/2", 5/8" & 3/4" Cable 4" drain



ARROW HEAD
Starting drill
PART # 20100037 - 3/8" or 1/2" Cable



1-1/2" "U" CUTTER
For cutting and scraping
PART # 20100180- 3/8" or 1/2" Cable



ROOT RIPPER
Heavy spring screws into root mass, while front hook tears into stoppage
PART # 75361228- 5/8" or 3/4" Cable



HEAVY DUTY SAW BLADES
For roots and other stoppages
PART # DESCRIPTION
75361080 5/8" or 3/4" Cable 3" drain
75361082 5/8" or 3/4" Cable 4" drain



TOTAL MAINTENANCE SOLUTIONS

HOUSTON
800/392-5066

ORLANDO
800/327-3022

GREENVILLE
800/476-2212

LOOK FOR US ON THE WEB AT: www.TMSSouth.com

TOOLS, FASTENERS & SEWER EQUIPMENT

SUPER-VEE

Double insulated unit with Vari-Speed switch and slide action chuck. Cleans drains 1-1/4" thru 3". Drum has 50 ft. capacity of 1/4" or 5/16" cable or 35 ft. of 3/8" cable.

PART #	DESCRIPTION
20100185	Basic unit with carrying case, 25 ft. x 1/4", 25 ft. x 3/8" cables, cutter set & one cartridge.
20100186	Basic unit with carrying case, 50 ft. x 1/4", 35 ft. x 3/8" cables, cutter set & one cartridge.
75362006	Cordless Super-Vee with case, 25 ft. x 1/4" cable, two batteries and charger.

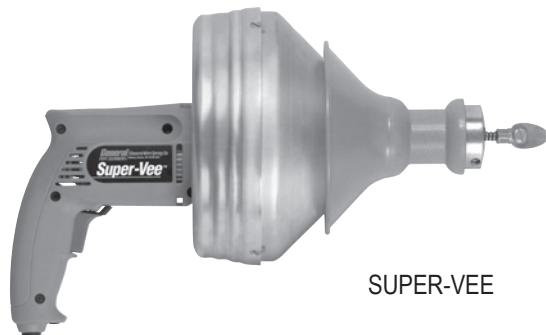

SUPER-VEE

SUPER-VEE REPLACEMENT CABLES & ACCESSORIES

PART #	DESCRIPTION
20100011	1/4" x 25 ft. with EI Basin plug head
40811001	1/4" x 25 ft. with Down Head
20100024	3/8" x 35 ft. with female connector
20100187	Metal carrying case
20100037	Arrow Head
20100039	Boring Gimlet
20100040	Down Head boring gimlet
20100038	1-1/4" Side Cutter blade (2 pieces)
20100178	Flexible arrow head



CORDLESS SUPER-VEE

SPEEDROOTER

For 2" lines thru 10" lines. Power feed handles 3/4", 5/8" & 1/2" cables. Maximum operating distance is 200 ft. Maximum drum capacity is 75 ft. of 3/4" or 100 ft. of 5/8" cable. Operator can vary cable speed from 0 to 20 ft. per minute.

PART #	DESCRIPTION
40811000	Basic unit with 1/2 HP motor, air foot switch, 20 ft. power cord, leather gloves, SRCS cutter set, and 100 ft x 5/8" cable in drum.

SPEEDROOTER REPLACEMENT CABLES & ACCESSORIES

PART #	DESCRIPTION
75361220*	33" Flexible leader
75361222*	Spear Head
20100176*	3" Side Cutter blades
20100177*	4" Side Cutter blades
20100181*	2" U-Cutter
75361080*	3" Heavy Duty Saw blade
75361082	4" Heavy Duty Saw blade
75361046	Air foot switch
20100182	3" Rotary Saw blade
20100183*	4" Rotary Saw blade
20100184*	Large Retrieving Tool
20100035	75 ft. x 3/4" cable
20100032	100 ft. x 5/8" cable
20100036	100 ft. x 3/4" cable
20100042	75' x 3/8" cable



* Items included in SRCS cutter set

MINI-ROOTER

For small drains 1-1/4" thru 3" and most 4" drains. Clears drains from roof-top to basement, including kitchen, bath and laundry drains. Maximum capacity is 75 ft. of 1/2" cable.

PART #	DESCRIPTION
75362010	Basic unit, drum, 1/3 HP motor w/reverse switch, air foot switch, leather gloves, cutter set and 75 ft. x 3/8" cable.
75362020	XP-Mini-rooter w/ power feed

MINI-ROOTER REPLACEMENT CABLES & ACCESSORIES

PART #	DESCRIPTION
20100037	Arrow Head
20100039	Boring Gimlet
20100175	2" Side cutter blade
20100180	1-1/2" U Cutter
20100179	Down Head fitting for 3/8" cable
20100042	75 ft. x 3/8" cable
20100043	75 ft. x 1/2" cable

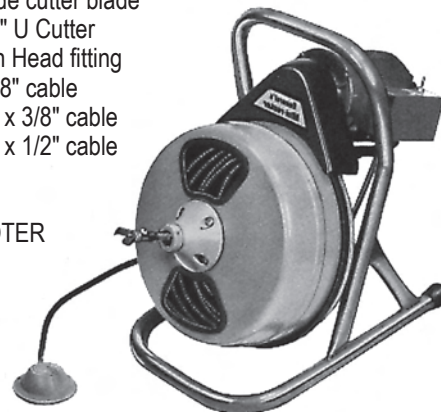

MINI-ROOTER



**TOTAL
MAINTENANCE
SOLUTIONS**

HOUSTON
800/392-5066

ORLANDO
800/327-3022

GREENVILLE
800/476-2212

LOOK FOR US ON THE WEB AT: www.TMSSouth.com

TOOLS, FASTENERS & SEWER EQUIPMENT

MARCO AUTO PAK 25

"Squeeze Ease" chuck, high impact plastic drum, variable speed motor. "Roll-A-Feed" feature allows for fully automatic 0 to 12 feet-per-minute feed and retrieval. Designed for 1-1/4" thru 2-1/2" drains. Maximum operating distance is 50 ft.

PART #	DESCRIPTION
75633002	Basic unit with 35 ft. x 3/8" cable and 3/8" head set.

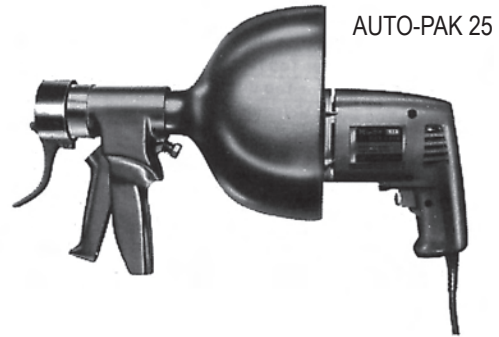













PICK-A-PACK REPLACEMENT CABLES AND ACCESSORIES

PART #	DESCRIPTION
75634002	3/8" Bore Head
75631070	3/8" Drop Head
75634006	3/8" Cutter Head
75634004	3/8" Coupling
75634008	35 ft. x 3/8" Cable

FOR ADDITIONAL MARCO SEWER MACHINES AND ACCESSORIES
PLEASE CALL US!

MARCO CUTTING HEADS

 <p>BORE HEAD PART # 75634002 - 3/8" cable PART # 75634010 - 1/2" cable</p>	 <p>RETRIEVER HEAD PART # 75634034- 3/4" cable</p>	 <p>OPEN CUTTER 4" PART # 75634028- 3/4" cable</p>	 <p>SPEAR FIN PART # 75634032- 3/4" cable</p>
 <p>OPEN CUTTER 1-1/2" PART # 75634016- 1/2" cable</p>	 <p>OPEN CUTTER 3" PART # 75634020- 1/2" cable PART # 75634026- 3/4" cable</p>	 <p>ROOT CUTTER PART # 75634038- 3/4" cable</p>	 <p>OPEN CUTTER 2" PART # 75634018- 1/2" cable</p>
 <p>HUNTER HEAD PART # 75634012 -1/2" cable</p>	 <p>AUGER HEAD PART # 75634036- 3/4" cable</p>	 <p>CUTTER HEAD PART # 75634006 - 3/8" cable</p>	 <p>OPEN CUTTER 6" PART # 75634030- 3/4" cable</p>
 <p>DROP HEAD PART # 75631070 - 3/8" cable PART # 75634014 - 1/2" cable</p>			



TOTAL MAINTENANCE SOLUTIONS

HOUSTON
800/392-5066

ORLANDO
800/327-3022

GREENVILLE
800/476-2212

LOOK FOR US ON THE WEB AT: www.TMSSouth.com

TOOLS, FASTENERS & SEWER EQUIPMENT

SPARTAN SEWER PRODUCTS

SPARTAN MODEL 100

- Holds up to 75' of cable
- Optional power feed & roll-aid
- Adjustable trunion for changing angle of cable feed



SPARTAN MODEL 300

- Ideal for medium jobs
- Slimline design
- Dependable quick start
- Dial-A-Cable Power Feed (manual feed optional)



SPARTAN MODEL 1065

- Totally enclosed, heavy duty Universal AC HP motor with reverse capability and water tight switch
- Senses need for more power for difficult blockages and automatically increases.
- Spartan Spar-matic™ Power Cable Feed with lever control (manual cable feed available)
- Inner drum rotates independently of outer drum to eliminate cable buckling and kinking
- 25' power cord with ground fault interrupter
- Electric on/off switch in front of operator for convenience and safety
- Air foot switch for hands-free operation
- Dial-A-Cable Power Feed allows you to switch cable sizes rapidly
- Extra strength aluminum magnesium construction
- Cable safety guide



O'BRIEN JETTERS

- Trailer Jettors
- Cart Jettors

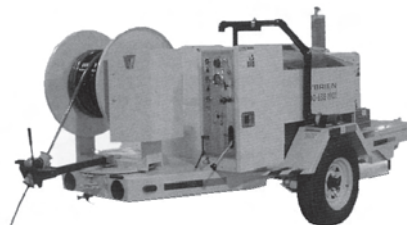

**FOR MORE INFORMATION ON THESE ITEMS
OR ADDITIONAL PRODUCTS
PLEASE CALL OUR FRIENDLY SALES STAFF.**



**TOTAL
MAINTENANCE
SOLUTIONS**

HOUSTON
800/392-5066

ORLANDO
800/327-3022

GREENVILLE
800/476-2212

LOOK FOR US ON THE WEB AT: www.TMSSouth.com

TOOLS, FASTENERS & SEWER EQUIPMENT

SPARTAN DRAIN CLEANING PARTS

CUTTER SETS FOR MODEL 100

PART #	DESCRIPTION
40811013	13/32" Cutter set
40811014	1/2" Cutter set



40811013

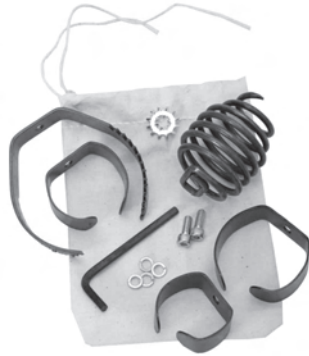

40811014

2" U-BLADE

PART # 02799000



3" U-BLADE

PART # 02786600



4" U-BLADE

PART # 02790900



2" BLADE HOLDER

PART # 02799300



3" - 4" BLADE HOLDER

PART # 02799400



SPEAR BLADE

PART # 02798800



REPLACEMENT CABLES

MODEL 1065

PART #	DESCRIPTION
04209901	3/4" x 25' No core cable
04209902	3/4" x 50' No core cable

MODEL 300

PART #	DESCRIPTION
03448703	1/2" x 50' Inner core cable
03448704	1/2" x 75' Inner core cable

MODEL 100

PART #	DESCRIPTION
03449005	5/16" x 50' Inner core cable
03449006	5/16" x 75' Inner core cable
03448806	13/32" x 100' Inner core cable

CABLE END OPTIONS

#4 MAGNUM - MALE AND FEMALE COUPLING

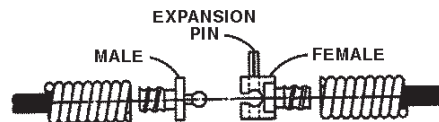

#6 ROD PLUG (ACCEPTS BLADES ONLY)



#8 ROD PLUG (ACCEPTS BLADES AND DROP HEADS)



**TOTAL
MAINTENANCE
SOLUTIONS**

HOUSTON
800/392-5066

ORLANDO
800/327-3022

GREENVILLE
800/476-2212

LOOK FOR US ON THE WEB AT: www.TMSSouth.com

TOOLS, FASTENERS & SEWER EQUIPMENT

RIDGID DRAIN CLEANING PRODUCTS

K-39 SINK MACHINE

With slide action chuck. Comes with carry case, 5/16" x 25' inner core cable with inner drum and bulb auger. 115V
TMS PART #20100071



K-3800 DRUM MACHINE

With standard equipment, C-32 3/8" x 75' cable, T-202 bulb auger, T-205 "C" cutter, T-211 spade cutter, A-13 pin key and pair of gloves.
TMS # 20100072

Replacement cable
C-32 3/8" x 75' inner core cable
TMS # 20100069



K-750 DRUM MACHINE

115V-60Hz, includes one pair of gloves, C-100 AUTOFEED, standard 3/4" tool set, and C-100, 100' x 3/4" cable.
TMS # 20100074

Replacement cable (see below)



CUTTER SET FOR 3/8" IC, 3/8" IW AND 1/2" IW CABLES

Includes T-202 bulb auger, T-205 "C" cutter, T-211 spade cutter and A-13 pin key

TMS # 20100075

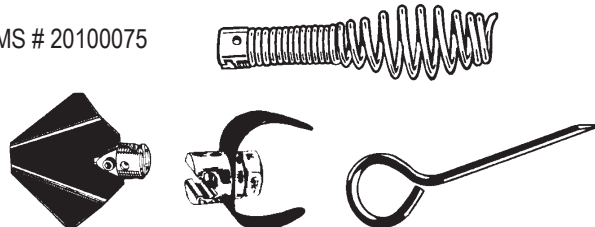

INNER CORE CABLE

C-29 3/4" x 50' inner core cable
TMS # 20100070



T-217 DROP HEAD

TMS PART # 20100076

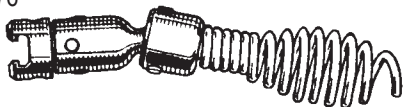

TRANSPORT CART

TMS # 20100073



NEED

- STRAIGHT AUGERS
- SPIRAL CUTTERS
- GREASE CUTTERS
- 4-BLADE CUTTERS
- SPADE CUTTERS
- KNIFE BLADE CUTTERS
- SPEAR BLADES
- SAWTOOTH CUTTERS
- DOUBLE CUTTERS
- 3-BLADE CUTTERS?

CALL US!



**TOTAL
MAINTENANCE
SOLUTIONS**

HOUSTON
800/392-5066

ORLANDO
800/327-3022

GREENVILLE
800/476-2212

LOOK FOR US ON THE WEB AT: www.TMSSouth.com

TOOLS, FASTENERS & SEWER EQUIPMENT

PROFESSIONAL TOOLS FROM



HEAVY DUTY PIPE WRENCH

PART #	DESCRIPTION
20301440	8" – max. OD 1/2"
20301441	10" – max. OD 1-1/2"
20301442	12" – max. OD 2"
20301443	14" – max. OD 2"
20301444	18" – max. OD 2-1/2"
20301445	24" – max. OD 3"



ALUMINUM PIPE WRENCH

PART #	DESCRIPTION
20301242	14" – max. OD 2"
20301243	18" – max. OD 2-1/2"
20301244	24" – max OD 3"

PLUMBERS PLIERS

PART #	DESCRIPTION
20301246	10" – max. OD 1-1/4"
20301247	12" – max. OD 1-1/2"



SANIGRIP PL PLIER

Plastic jaws
protect
fittings
PART #
20301275



ROGRIP® SELF ADJUSTING MULTI-PURPOSE PLIERS

10" – max. OD 1-5/8"
PART # 20301248



STRAP AND FITTINGS WRENCH

12" long, 3" max OD
PART # 20301305



CUTTERS

MINIMAX TUBE CUTTER FOR COPPER TUBES

PART #	DESCRIPTION
20301249	1/8" – 1-1/8"
20301255	2 pk cutter wheel replacement



PRO 35 TUBE CUTTER FOR COPPER & ALUMINUM

PART #	DESCRIPTION
20301250	1/4" – 1-3/8"
20301255	2 pk cutter wheel replacement



ROTRAC TUBE CUTTERS

PART #	DESCRIPTION
20301251	1/8" – 1-1/8"
20301252	2 pk cutter wheel replacement
20301253	1/4" - 1-5/8"



RATCHET TELESCOPIC CUTTER

PART #	DESCRIPTION
20301295	1/8" – 2-5/8"
20301255	2 pk cutter wheel replacement



DEBURRING TOOL

PART #	DESCRIPTION
20301245	Deburring tool



ROCUT 32TC PEX CUTTER

PART #	DESCRIPTION
20301300	Pex cutter
20301297	Replacement blade



PLASTIC PIPE SHEARS – ROCUT PROFESSIONAL

PART #	DESCRIPTION
20301298	Pipe shears, max OD 1-5/8"
20301299	Replacement blade
20301301	Pipe shears, max OD 2"
20301302	Replacement blade
20301303	Pipe shears, max OD 3"
20301304	Replacement blade



20301298



20301301



20301262



TOTAL MAINTENANCE SOLUTIONS

HOUSTON
800/392-5066

ORLANDO
800/327-3022

GREENVILLE
800/476-2212

LOOK FOR US ON THE WEB AT: www.TMSSouth.com

TOOLS, FASTENERS & SEWER EQUIPMENT

SOLDERING AND BRAZING TORCHES FROM



SUPER FIRE 3

Heavy-duty, ergonomic, brazing torch
Designed to provide convenience and safety to the user. The gas adjustment offers precise flame adjustment and the swirl-flame burner tip "wraps" around the fitting for quick and even heating with MAPP® propane. Built in regulator provides a consistent flame in all positions.

Torch handle with swirl-flame burner
 PART # 20301292

- Reliable lighting up to 30,000 ignitions
- Lights instantly, shuts off if dropped or released
- Provides continuous flame for hands-free use
- Non-return safety valve immediately blocks the gas flow in both directions
- Lightweight and easy to use
- Fine regulating valve allows for precise flame adjustment
- Heavy duty construction withstands exposure to dust, sand and water

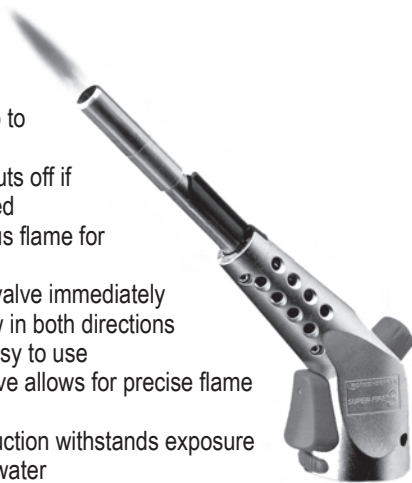

SWEATBOX™ II

A handy kit that includes all the tools needed to sweat copper.

- SUPER FIRE 3 Heavy duty torch
- 35 PRO Tube cutter
- MINIMAX Tube cutter
- Carry case

PART # 20301296



ROFIRE SWIVEL TORCH

Head swivels 360° to make reaching the soldering area easier. Reliable Piezo ignition switch with cyclone burner.

PART # 20301306



FREEZE-PAK

Instant pipe freezing kit
The FREEZE-PAK is the ideal way to make quick repairs without draining or interruption of water supply. Quick Freeze spray produces a temporary ice plug in plumbing and heating systems that will last up to 30 minutes.



PART #	DESCRIPTION
20301294	Kit contains 1 can Quick Freeze Spray, 2 foam pipe jackets and 4 plastic ties.

TORCH REFLECTOR

Protects surrounding materials or walls when soldering pipes.

PART # 20301293



TOOLS, FASTENERS & SEWER EQUIPMENT

SPANNER WRENCHES

PART #	DESCRIPTION
64001504	Schofield spanner wrench
20200139	Bubbler spanner wrench

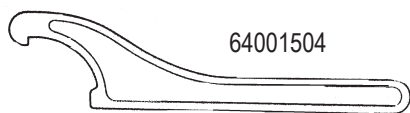

64001504



20200139

SPUD WRENCHES

PART #	DESCRIPTION
20200134	Inside Expansion Wrench. For spuds, basket strainers, pipe nipples. For inside 1/2", 3/4", 1" and larger.
20200204	Spud Wrench (inside), 1" - 4" capacity. Can be used on sink strainers, P.O. Plugs and waste and overflows.
20200205	Spud chuck and nipple extractor
20200148	Adjustable spud wrench

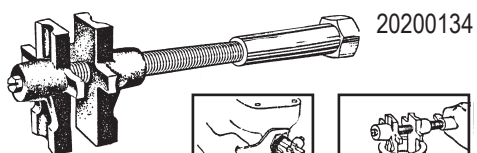

20200134



Closet Spuds

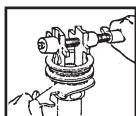

Basket Strainers

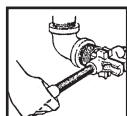

Pipe Nipples

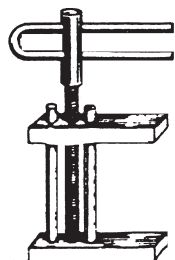

20200204

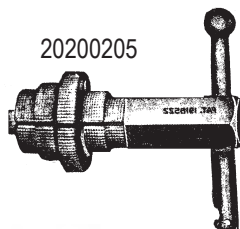
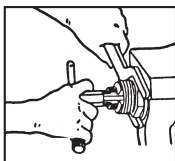

20200205

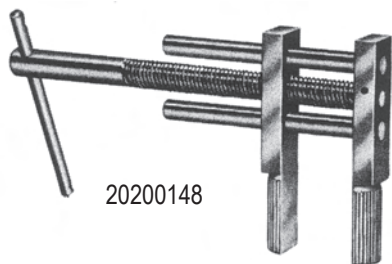

20200148

STRAINER & COMBINATION WRENCHES

PART #	DESCRIPTION
20200167	3-IN-1 Combination Wrench spuds, strainers, slip joint nuts
20200206	Strainer locknut wrench with hinged jaw
20200207	All-purpose wrench, 1"-3" capacity for strainer locknuts and slip joint nuts.
20200208	4-IN-1 Combination Wrench for spuds, strainers and slip joint nuts.
20200209	Strainer Wrench, holds basket strainer body in position while installation is made.
20401014	Strainer Wrench for trip lever or twist handle strainers.
64001505	Schofield Strainer Wrench
20200210	Basket strainer wrench fits 3-3/8" strainer locknut



20200167



20200206

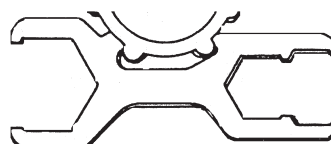

20200208



20200207

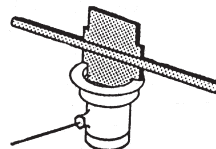

20200210

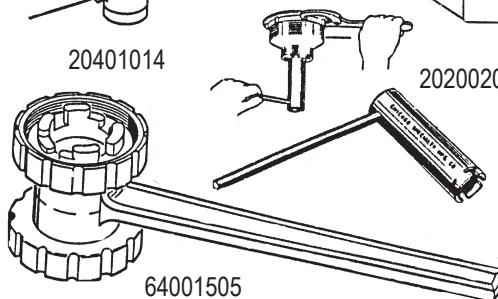

20401014

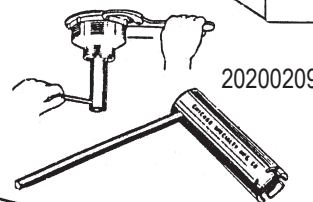

64001505

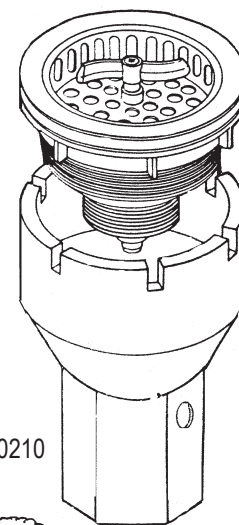

20200209

TOILET SEAT WRENCHES

PART #	DESCRIPTION
20401017	14-IN-1 Toilet Seat Hinge Nut Wrench
64161572	Seat Hinge Nut Wrench



20401017

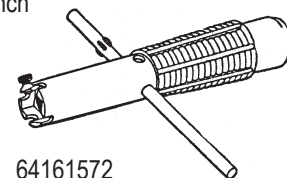
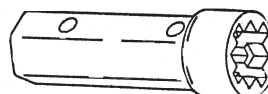

64161572



**TOTAL
MAINTENANCE
SOLUTIONS**

HOUSTON
800/392-5066

ORLANDO
800/327-3022

GREENVILLE
800/476-2212

LOOK FOR US ON THE WEB AT: www.TMSSouth.com

TOOLS, FASTENERS & SEWER EQUIPMENT

FAUCET SEAT DRESSERS

PART #	DESCRIPTION
20200211	Faucet seat dresser, 3 cutters: 1/2", 11/16", 3/4" Reversible double cone guide.
64161404	Faucet seat dresser, economy grade. 4 cutters 1/2", 5/8", 3/4", 7/8"
64161406	Faucet repair tool with 1/2" & 5/8" cutters. 4 washers and 1 plated screw.

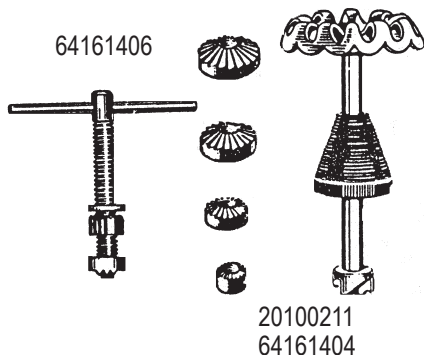

PIPE WRENCHES

PART #	DESCRIPTION
64342130	10" Heavy duty pipe wrench. Capacity 1/8" to 1-1/2"
64342140	12" Heavy duty pipe wrench. Capacity 1/8" to 2"
20200173	14" Heavy duty pipe wrench. Capacity 1/4" to 2"
20200174	12" Self adjusting pipe wrench
20200175	14" Self adjusting pipe wrench
64000120	Ridgid Rapidgrip (not shown)

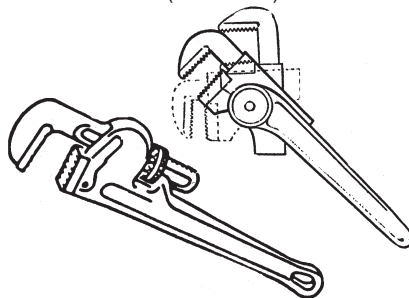

GETTA-GRIP™ LOCKING PLIERS

All pliers are made of chrome vanadium steel with comfortable TPR Getta-Grip™ handles for grip and comfort and have an adjustable locking action.

PART #	DESCRIPTION
64851154	6" Long Nose Pliers
64851151	7" Lock Grip Pliers
64851150	5" Lock Grip Pliers



FAUCET REPAIR KIT

10-24 Tap
PART #
20200212



ANGLE NOSE PLIERS

PART #	DESCRIPTION
20200216	8" Slip joint pliers
20300372	10" Angle nose pliers with plastic grip



PIPE WRENCH PLIERS

PART #	DESCRIPTION
20200223	4" pliers w/ plastic grip
20200176	10" Heavy duty pipe pliers w/ plastic grip
20200224	13" Heavy duty pipe pliers w/ plastic grip
20200178	10" Heavy duty smooth jaw pliers w/ plastic grip



STRAP WRENCHES

PART #	DESCRIPTION
20200213	Strap wrench, 7" handle, 2" IPS capacity
20200214	Strap wrench, 11-1/2" handle, 3" IPS capacity
20200215	Rubber strap wrench, small
64001450	Rubber strap wrench, large

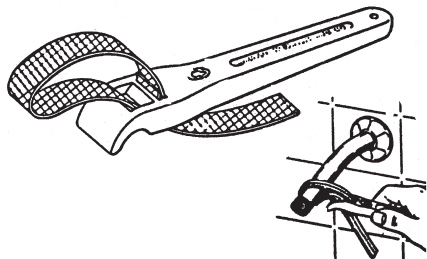

ADJUSTABLE WRENCHES

PART #	DESCRIPTION
20200218	4" Adjustable wrench
20200219	6" Adjustable wrench
20200220	8" Adjustable wrench
20200221	10" Adjustable wrench
20200222	12" Adjustable wrench

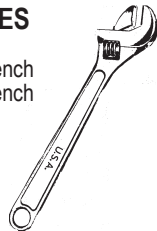

8" STUBBY ADJUSTABLE WRENCH

- Chrome vanadium steel
- Precision SAE & metric scale
- Full size 8" head

PART # 20200156



BASIN BUDDY

Use on basin metal locknuts, basin PVC locknuts, basin coupling nuts and toilet tank coupling nuts

PART #
20200154

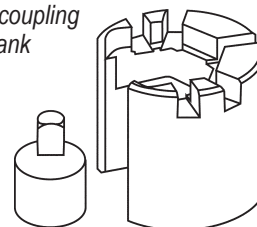

**TOTAL
MAINTENANCE
SOLUTIONS**

HOUSTON
800/392-5066

ORLANDO
800/327-3022

GREENVILLE
800/476-2212

LOOK FOR US ON THE WEB AT: www.TMSSouth.com

TOOLS, FASTENERS & SEWER EQUIPMENT

HANDLE PULLERS

PART #	DESCRIPTION
20200155	Faucet handle puller
20300370	Handle hammer
20200190	"Big Yank" Puller
64004668	"Big Yank Sr." Puller

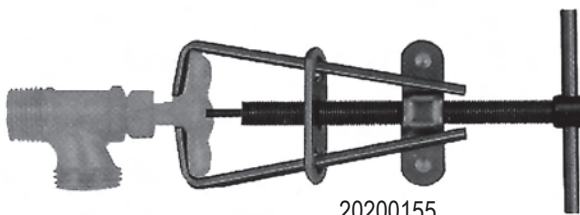

20200155

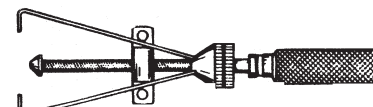

20300370
Impact type puller

P.O. PLUG & DRAIN WRENCHES

PART #	DESCRIPTION
20200191	P.O. Plug wrench, holds pop-up plugs and basket strainers in position.
20401024	Dumbbell tub drain & closet spud wrench. Fits 95% of all tub drains. Fits 1-1/2" & 2" closet spuds.
64001508	Strainer wrench. For removal of bath waste & P.O. plugs.
64027060	Inside out wrench for tub drains

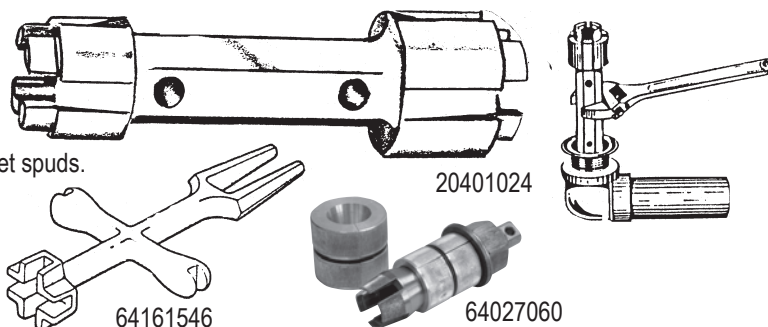

64161546

20401024

64027060

SOCKET WRENCHES

PART #	DESCRIPTION
20200192	21/32" x 27/32" socket wrench
20200193*	29/32" x 31/32" socket wrench
20200194	1-1/32" x 1-3/32" socket wrench
20200195	1-5/32" x 1-9/32" socket wrench
20200196	1-11/32" x 1-7/16" socket wrench
20201920	Socket set, includes 21/32" thru 1-7/16"

* Fits Kohler Trend, Union Brass & Gerber

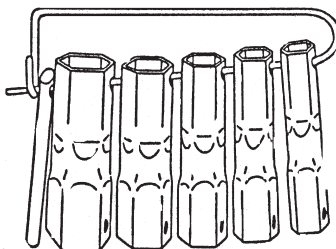

ZURN DRUM TRAP WRENCH

PART # 64990150

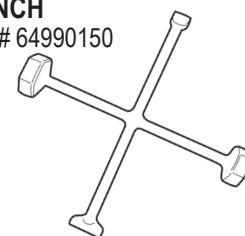

NO HUB TORQUE (RATCHETING) WRENCH

PART # 40800351

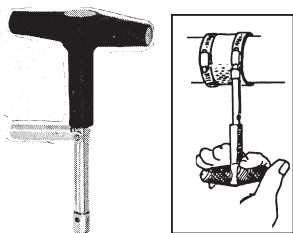

DISPOSAL WRENCH

Free jammed disposal blades without engaging hands.
PART # 64161524

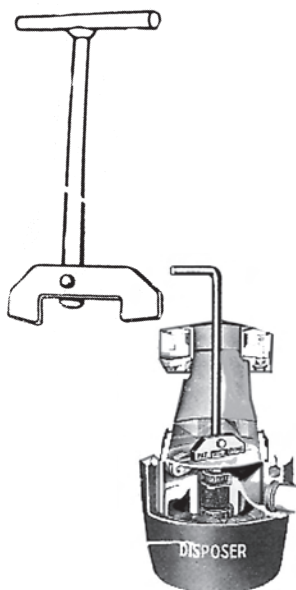

SPECIAL APPLICATION SOCKET WRENCHES

PART #	DESCRIPTION
20200197	American Standard colony tub stem wrench
20200198	Combination wrench for Savoy
64321710	Dual wrench for Sayco tub stems
20200200	Indiana Brass tub stem wrench
20200201	Price Pfister tub stem wrench
20200151	Kohler tub stem wrench
20200202	Gerber bonnet wrench
64321750	Harcraft tub stem wrench
20200153	Delany main seat wrench

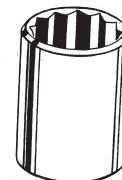

20200153

20100197



20100198
20100199



20100201
20200151

20100200



64321750

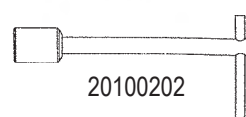

20100202

DRUM TRAP PLUG WRENCH

PART # 20200203
Four sizes: 3/4", 1", 1-1/8", 1-3/8"

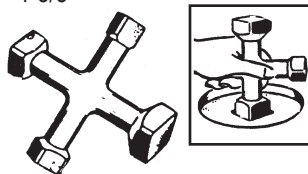

HOUSTON
800/392-5066

ORLANDO
800/327-3022

GREENVILLE
800/476-2212

LOOK FOR US ON THE WEB AT: www.TMSSouth.com

TOOLS, FASTENERS & SEWER EQUIPMENT

SPECIAL APPLICATION WRENCHES

PART #	DESCRIPTION
40140184	Moen cartridge removal tool
10100345	Same as #40140184, non-OEM
20200225	Crane Dial-ese wrench
64969964	Sloan flush valve wrench
20205308	Sloan "SuperWrench"
20200153	Delany main seat wrench
64326167	4-n-1 Compression Stop Wrench
20200171	Sloan Tailpiece (spud) wrench
20200004	Zurn Hydrant Wrench Sizes 3/8", 9/32", 5/16" and 1/4"

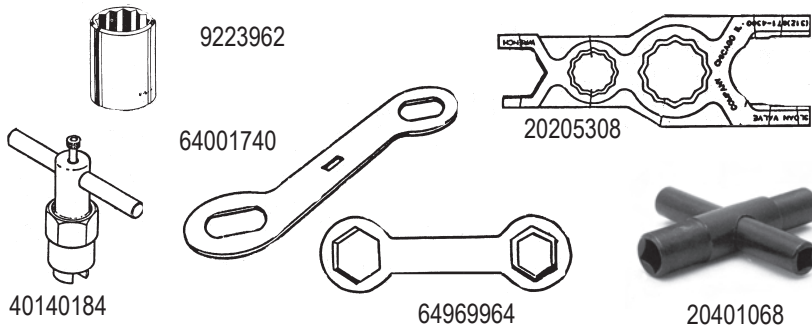

MORE FLUSH VALVE TOOLS ON PAGE 11-3

INTERNAL PIPE WRENCHES

PART #	DESCRIPTION
20200227	3/8" Internal pipe wrench
20400127	1/2" Internal pipe wrench
20400128	3/4" Internal pipe wrench
20200228	Internal pipe wrench kit

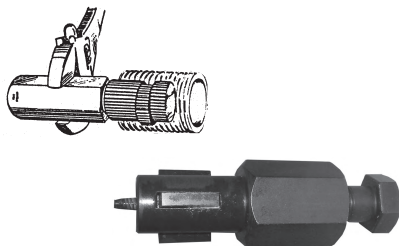

RADIATOR NIPPLE WRENCH

Radiator Nipple extractor wrench. Capacity 1/2", 3/4", 1-1/4", 1-1/2" & 2" nipples.
PART # 20200229

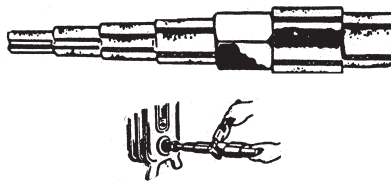

SAWS AND BLADES

PART #	DESCRIPTION
20200230	Hacksaw frame, uses 12" blades
20200169	Teeny Weeny Hacksaw
20200168	Economy Hacksaw

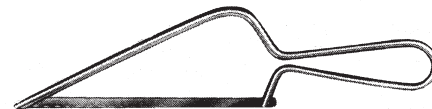
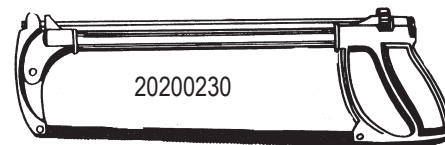

20200169

XTRACTOR TOOLS

PART #	DESCRIPTION
20300349	1/4" - 1/2" 5 piece set
20300350	7/16" - 5/8" 5 piece set
20300351	1/4" - 5/8" 10 piece set



SAW BLADES

20200179	Blade for Teeny Weeny Hacksaw
20200231	12" high speed blade 18 teeth
20200232	12" high speed blade 24 teeth
64331156	12" high speed blade 32 teeth



NIPPLE & SCREW EXTRACTORS

Spiral fluted type, left hand spiral works itself into drilled hole and removes broken piece without damage to threads.

PART #	DRILL REMOVES	
	SIZE	BOLTS & SCREWS
64081002	5/64"	3/32 to 5/32
64081004	7/64"	5/32 to 7/32
64081006	5/32"	7/32 to 9/32
64081008	1/4"	9/32 to 3/8 & 1/8" pipe
64081010	19/64"	3/8 to 5/8 & 1/4" pipe
64081012	13/32"	5/8 to 7/8 & 3/8" pipe
64161752	17/32"	7/8 to 1-1/8 & 1/2" pipe
64161754	13/16"	1-1/8 to 1-3/8 & 3/4" pipe
64161756	1-1/16"	1-3/8 to 2 & 1" pipe

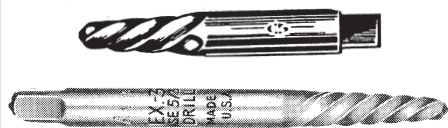

CABLE SAW FOR PVC PIPE

Cuts PVC pipe in tight spots with little clearance, faster than a hacksaw in close quarters.

PART # 64001040

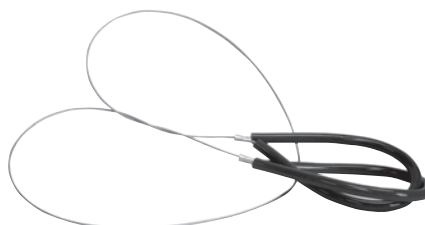

PVC PIPE SAWS

PART #	DESCRIPTION
64721178	PVC Pipe saw with 18" blade
20301254	PVC Pipe saw 19" overall

64721178

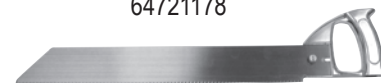

20301254



TOTAL MAINTENANCE SOLUTIONS

HOUSTON
800/392-5066

ORLANDO
800/327-3022

GREENVILLE
800/476-2212

LOOK FOR US ON THE WEB AT: www.TMSSouth.com

TOOLS, FASTENERS & SEWER EQUIPMENT

TOOLS AND BLADES FROM LENOX TOOLS

LAZER™ BLADES

Best for Heavy Metal Cutting



PART #	TPI*	LENGTH	WIDTH	THICKNESS	APPLICATIONS
20301254	14	12"	1"	.042	Steel rod, black pipe
20301256	18	12"	1"	.042	Copper pipe, black pipe

BI-METAL RECIPROCATING BLADES

Cuts stronger, faster and lasts longer. Optimized for every cutting application.



PART #	TPI*	LENGTH	WIDTH	THICKNESS	APPLICATIONS
20301257	6	12"	3/4"	.050	Fast cutting, roughing in work & nail embedded wood
20301258	10	6"	3/4"	.050	Nail embedded wood, composition materials & plastics. Pipe, carbon steel, stainless steel, 1/8" – 1/4" thick, demolition work, fire and rescue
20301259	10	8"	3/4"	.050	
20301260	14	4"	3/4"	.035	Pipe, structural steel, stainless steel, 3/32" - 1/4", non-ferrous metal
20301261	14	6"	3/4"	.035	
20301262	18	4"	3/4"	.035	Structural steel, pipe, conduit, stainless steel, 1/16" – 3/16" thick, non-ferrous metal, 1/16" – 5/16"
20301263	18	6"	3/4"	.035	
20301264	18	8"	3/4"	.035	
20301265	24	4"	3/4"	.035	All metals less than 1/8" thick, tubing, conduit and trim
20301266	24	6"	3/4"	.035	

BI-METAL HOLE SAWS

Engineered for Optimum Performance in Wood or Metal



PART #	DIA.	PIPE TAP	PIPE ENTRANCE
20301269	3/4"	1/2"	3/8"
20301270	7/8"	3/4"	1/2"
20301271	1-1/8"	1"	3/4"
20301272	1-1/2"	1-1/4"	
20301273	1-3/4"	1-1/2"	1-1/4"
20311274	2-1/8"		
20301275	2-1/4"	2"	
20301276	2-9/16"		

HOLE SAW ARBORS AND ACCESSORIES



PART #	FITS HOLE SAWS	SHANK TYPE	SHANK SIZE
20301277	20L-96L	Hex	1/2"+
20301278	9L-19L	3-Sided	1/4"+

PART #	DESCRIPTION
20301279	Pilot drill, chuck size 1/4, for 20301277 and 20301278
20301280	Arbor adaptor for 20301278

MASTER-GRIT™ RECIPROCATING BLADES

Best for cutting abrasives



PART #	TPI*	WIDTH	THICKNESS	APPLICATIONS
20301267	6	3/4"	.032	Cast iron, fiberglass, ceramic wall tile, clay, pipe, stone, brick, plaster and marble.
20301268	8	3/4"	.040	

HIGH TENSION HACKSAW FRAME

PART # 20301283



PVC/ABS PLASTIC PIPE HAND SAW

PART #	DESCRIPTION
20301313	18" blade & handle
20301314	12" replacement blade
20301315	18" replacement blade

VARI-BIT STEP DRILL BIT

Chuck size 3/8"
PART # 20301282



BI-METAL HACKSAW BLADES



Blade specifications		
PART #	TPI*	LENGTH x WIDTH (inches)
20301284	18	10 x 1/2
20301285	24	10 x 1/2
20301286	32	10 x 1/2
20301287	18	12 x 1/2
20301288	24	12 x 1/2
20301289	32	12 x 1/2

10 PIECE PLUMBER'S KIT

Bi Metal Hole Saw Kit
3/4", 7/8", 1-1/8", 1-1/2", 1-3/4", 2-1/4", 2 arbor, one pilot drill and one arbor adapter.
PART # 20301281

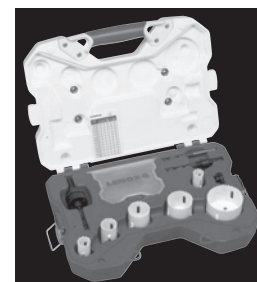

*TPI = Teeth per inch



TOTAL MAINTENANCE SOLUTIONS

HOUSTON
800/392-5066

ORLANDO
800/327-3022

GREENVILLE
800/476-2212

LOOK FOR US ON THE WEB AT: www.TMSSouth.com

TOOLS, FASTENERS & SEWER EQUIPMENT

PLASTIC FITTING SAVER

Works on PVC & ABS pipe & fittings both pressure & DWV. Bit leaves fittings clean and ready for solvent welding. All bits work on schedule 40 and 80.

PART #	SIZE
64001214	1/2"
64001216	3/4"
64001218	1"
64001220	1-1/4"
64001222	1-1/2"
64001224	2"

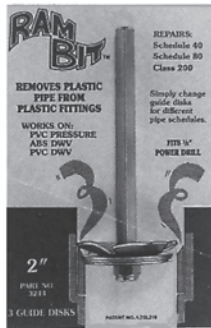

INSIDE PIPE CUTTERS

Pipe cutter for plastic pipe. Cutter has 3" shaft fits 1/4" drill or larger. Comes with 2 blades.

PART #	DESCRIPTION
64691436	Inside pipe cutter with extra blade
64691438	Replacement blades (2)

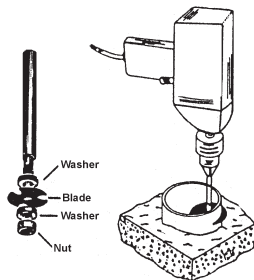

FOLDING POCKET UTILITY KNIFE

Knives have a quick blade change feature that requires no tools and accepts standard utility knife blades. Also includes a folding lock for safety and a belt clip. Includes a 5 blade dispenser. Part # 20300361



STUBBY GEARLESS RATCHET DRIVER

- Gearless design for smooth operation
- Stubby design for tight, confined areas
PART # 64851030



POWERS SPECIAL TOOLS

PART #	DESCRIPTION
24000100	Seat wrench for removal of piston cylinder from 427 Type H Hydroguard
24000102	Cartridge puller for removing balancing cartridge

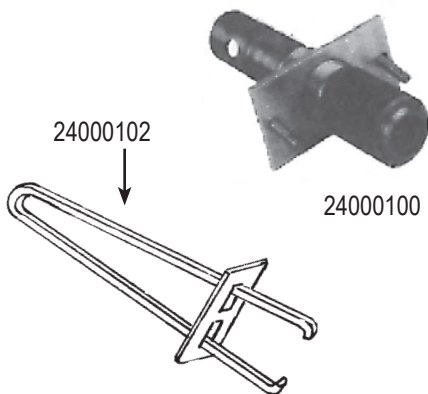

LOOKING FOR A SPECIAL TOOL? CALL US, WE CAN HELP YOU FIND IT!

KOHLER WRENCHES

PART #	DESCRIPTION
20401106	Niedecken seat wrench - exposed valves
20401104	Niedecken seat wrench
20401105	Niedecken bushing - all valves
09890070	Bonnet wrench (not shown)
20401107	Bonnet wrench - Triton & Constellation bath fixtures
09891430	Seat wrench - Trend

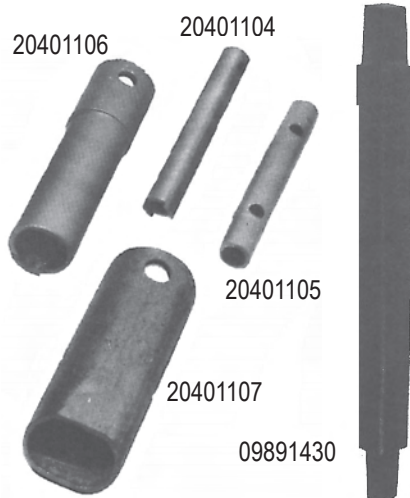

SYMMONS WRENCHES

PART #	DESCRIPTION
20401102	Seat socket wrench
23820470	Seat tool
20401103	Cold seat removal tool for pressure balancing valves including Safetymix'ette'

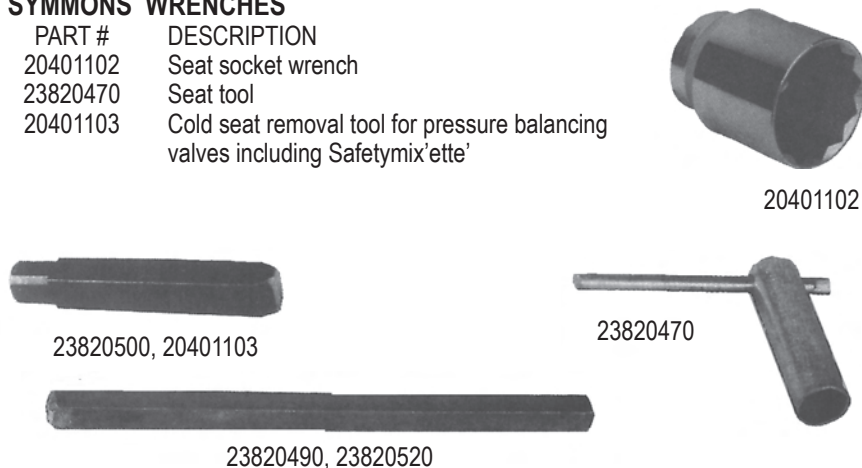

HOUSTON
800/392-5066

ORLANDO
800/327-3022

GREENVILLE
800/476-2212

LOOK FOR US ON THE WEB AT: www.TMSSouth.com

TOOLS, FASTENERS & SEWER EQUIPMENT

5-BIT HEX SOCKET PIN-HEAD KIT

Includes bits in the following sizes: 3/32", 1/8", 5/32", 3/16", and 7/32"
PART # 64801050



DELTA TOOLS

PART #	DESCRIPTION
20401100	Bonnet removal tool
20401101	Pick tool
05221055	Hex key and cam remover
05221722	Nut and wrench

BASIN WRENCHES

PART #	DESCRIPTION
20200149	Basin wrench, 11" handle, 1/2" to 1-1/8" capacity.
20200172	Basin wrench, 15" handle, 1/2" to 1-1/8" capacity.
20200003	Telescoping basin wrench, 10" to 17" handle with 3/8" to 1-1/4" capacity.

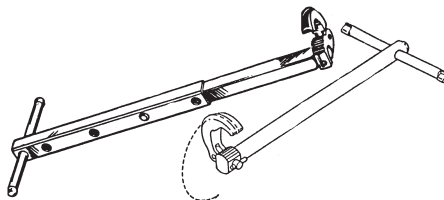

METER KEYS/PROBES

PART #	DESCRIPTION
20401001	Water meter key 3/4" x 36"
20401069	Utility probe 48"
20401019	Probe rod 3/8" x 5ft. S/S tip
64041012	Tip for probe rod

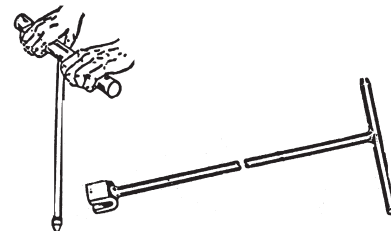

ZURN WONDER WRENCH

PART # 20200150



TORX DRIVER KIT

Kit contains 7 bits. Bits included are T8, T9, T10, T15, T20, T25, & T27.

PART # 64990078

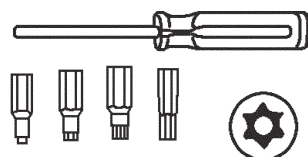

FLASHLIGHTS FROM TERRALUX

WORK LIGHTS

PART #	DESCRIPTION
20401030	80 LED Cordless/Rechargeable 115V AC & 12V
20401031	60 LED Cordless/Rechargeable 115V AC & 12V
20401032	30 LED Cordless/Rechargeable 115V AC & 12V

WORK LIGHT ACCESSORIES

20401033	Work light magnetic clamp
20401034	Work light Flexible magnetic clamp



TASK LIGHTS

PART #	DESCRIPTION
20401035	ClipLight clips to hat, belt
20401036	LightStar1 mini flashlight w/ headband
20401037	LightStar3 flashlight aircraft aluminum
20401038	FlareStar 30 LED Emergency flasher RED
20401039	FlareStar 30 LED Emergency flasher AMBER

LED UPGRADE KITS

PART #	DESCRIPTION
20401040	MiniStar5 for 4, 5 or 6 C&D cell Maglite®*
20401041	Upgrade for the AA and AAA MiniMag®*
20401042	Universal upgrade kit for 2-6 cell Maglites®*
20401043	MiniStar2 for MiniMag®*
20401044	Tail cap switch for MiniMag®* + Lens



* ©2007 TerraLUX, Inc. All rights reserved. Patent Pending. TerraLUX is not affiliated with Mag Instrument, Inc., which owns the Maglite® and Mini Maglite® trademarks and the trademark shape, style and overall appearance of the Mini Maglite® flashlight. The Mag Instrument trademark is here used only to identify the flashlights with which TerraLUX intends its upgrades to work. The TerraLUX Light Engine is not made, endorsed or sponsored by Mag Instruments, Inc.



**TOTAL
MAINTENANCE
SOLUTIONS**

HOUSTON
800/392-5066

ORLANDO
800/327-3022

GREENVILLE
800/476-2212

LOOK FOR US ON THE WEB AT: www.TMSSouth.com

TOOLS, FASTENERS & SEWER EQUIPMENT

FLASHLIGHTS & LANTERNS

PART #	DESCRIPTION
64733000	Pocket-Mate miniature (4.8") flashlight with 2 AAA batteries
64733001	Replacement bulbs (2) for Pocket Mate

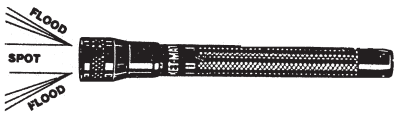

PART #	DESCRIPTION
64733002	Streamlight Jr. Flashlight is 5.6" long and weighs 3 ounces with 2AA batteries.
64733003	Nylon holster for Streamlight Jr.
64733004	Replacement bulbs (2) for Streamlight Jr.

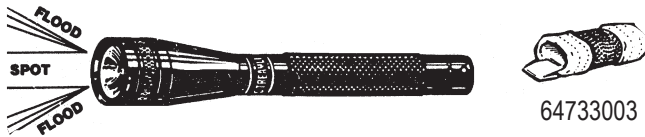

PART #	DESCRIPTION
64731005	2 cell D size Workhorse flashlight with batteries.
64731010	Sealed beam lantern bulb only

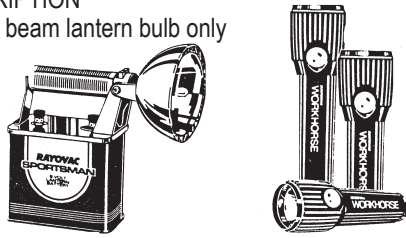

LED FLASHLIGHTS

Long life LED's for wide, even illumination. Corrosion proof aluminum construction. AAA batteries required.

PART #	DESCRIPTION
20300355	5 LED Flashlight
20300357	3 LED Flashlight – Positive action push on/off button



GENERAL PURPOSE LANTERN

PART #	DESCRIPTION
64731004	Gen. Purpose lantern without battery



BATTERIES & BULBS

PART #	DESCRIPTION
30100058	Alkaline D size battery 1.5 volt (each)
30100057	Alkaline C size battery 1.5 volt (each)
30100044	4 Pk Alkaline AA size battery 1.5 volt
30100060	4 Pk Alkaline AAA size battery 1.5 volt
30100059	Alkaline 9 volt size battery (each)
64731000	6 volt spring terminals battery
64731008	6 volt screw terminals battery

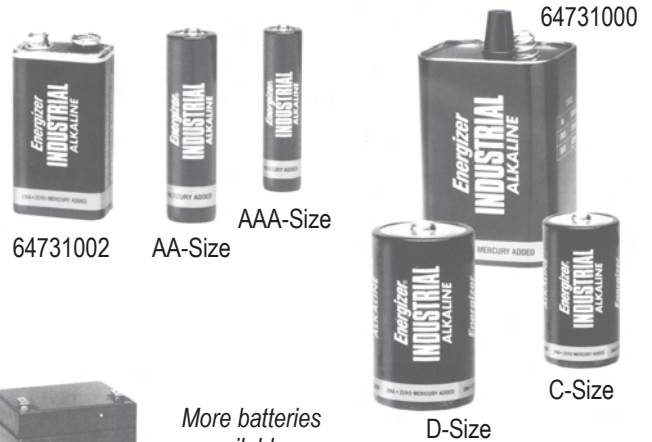

More batteries available...
Call us for all your DC power needs!



HOLD ZIT STRAPS

Rubber straps are perfect for holding tools, equipment and other items in place. Throw away your rope and string and replace them with Hold Zit straps.

PART #	LENGTH
20301434	9"
20301435	15"
44729024	21"
44729026	31"



LUGGAGE RACKS



TRUNK LIDS

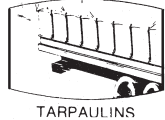

TARPAULINS

MECHANICAL FINGERS

PART #	DESCRIPTION
20301436	24" Mechanical fingers
64001750	36" Mechanical fingers

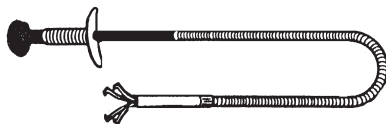

TOTAL MAINTENANCE SOLUTIONS

HOUSTON
800/392-5066

ORLANDO
800/327-3022

GREENVILLE
800/476-2212

LOOK FOR US ON THE WEB AT: www.TMSSouth.com

TOOLS, FASTENERS & SEWER EQUIPMENT

SCREWDRIVERS

PHILLIPS SCREWDRIVERS



PART #	DESCRIPTION
20301400	6" Phillips head for screw sizes 2 to 5
20301401	10" Phillips head for screw sizes 10 to 16



SLOTTED SCREWDRIVERS



PART #	DESCRIPTION
64361054	6-1/4" Slotted head with 5/16" blade
64361056	6" Slotted head with 3/16" blade
64361058	7-3/4" Slotted head with 3/16" blade
20301402	8-1/4" Slotted head with 1/4" blade
20301403	10-1/4" Slotted head with 1/4" blade
64361064	11-3/4" Slotted head with 3/16" blade
64361066	12-1/2" Slotted head with 5/16" blade

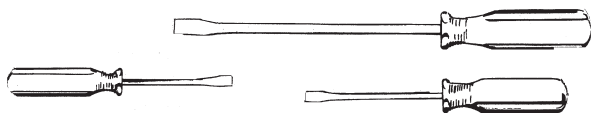

SCREWDRIVER BITS

PART #	DESCRIPTION
20401005	4 in 1 Screwdriver w/2 slotted & 2 phillips bits
20301404	Slotted bit for 4 in 1
20301405	Phillips bit for 4 in 1
64311026	Handle for 4 in 1
64311028	Socket for 4 in 1
64311030	2 in 1 screwdriver with 1 slotted & 1 phillips bit
64311032	Bit for 2 in 1
20401015	6 in 1 screwdriver

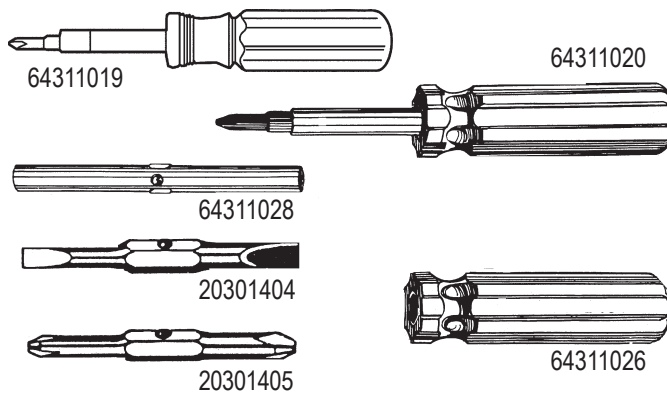

MAGNETIC SCREWDRIVER SET

Kit contains magnetic driver and two phillips (#1, #2) and two slotted (8/16", 9/32") bits. Bits are stored in handle.

PART #	DESCRIPTION
64990035	Slotted & phillips set
64990411	#1 phillips replacement bit
64990412	#2 phillips replacement bit
64994316	3/16" slotted replacement bit
64994932	9/32" slotted replacement bit

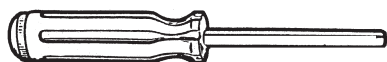
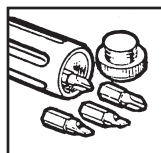

SLOTTED SCREW HOLDING DRIVERS

Split-blade screw holding driver wedges into screw slot. Positive gripping power holds, starts & drives slotted screws including self-tapping types.

PART #	BLADE SIZE DIA. X LENGTH
64997021	1/8" x 3"
64997023	1/8" x 3"
64997028	1/8" x 8"
64997034	3/16" x 4"
64997036	3/16" x 6"
64997046	1/4" x 6"

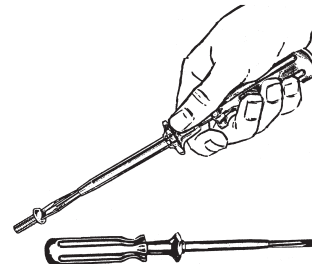

Note: Precision blade for use with small precision screws

MEGAPRO® 15IN1 TAMPERPROOF

The 15in1 is a must for all commercial/industrial tradesmen. The 15in1 Tamperproof comes loaded with the most common security bits, including: Spanner, Hex pin and Star pin.

Includes the following bits:

- 1/8 + 9/64
- 5/32 + 3/16
- 6 + 8
- 10 + 12
- 10 + 15
- 27 + 30
- 20 + 25



PART # 20401013

AUTOLOADER™ MULTI-BIT SCREWDRIVER

The world's only automatic loading multi-bit screwdriver. Exchanges screwdriver bits in less than 2 seconds flat. Pull back handle, index and select bit, push handle forward and your bit of choice is delivered. Pump action mechanism makes changing a breeze.

PART # 20401003



**TOTAL
MAINTENANCE
SOLUTIONS**

HOUSTON
800/392-5066

ORLANDO
800/327-3022

GREENVILLE
800/476-2212

LOOK FOR US ON THE WEB AT: www.TMSSouth.com

TOOLS, FASTENERS & SEWER EQUIPMENT

MAGNETIC DRILL CHUCKS - FOR HEX HEAD SCREWS

PART #	SIZE	LENGHT
20300000	1/4"	1-3/4"
20300002	1/4"	4"
64331072	5/16"	1-3/4"
20300003	3/8"	1-3/4"

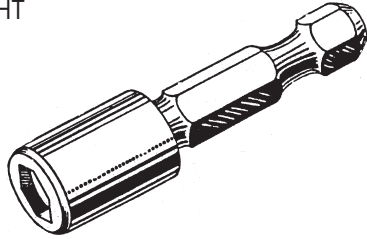

HEX KEYS - POCKET SETS

PART #	DESCRIPTION
20301406	Hex key set short .050, 1/16, 5/64, 3/32, 7/64, 1/8, 9/64, 5/32 & 3/16
64331465	Hex key set, 9 piece - 5/64-1/4
20401067	Hex key set, 3/16" - 3/8"

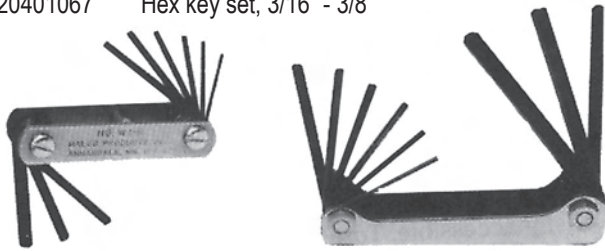

"T" HANDLE HEX KEY SET

PART #	DESCRIPTION
64331466	"T" handle (6") Hex key set 10 pc

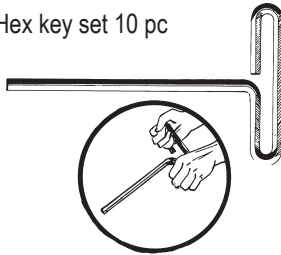
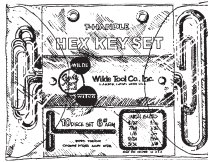

TAMPER RESISTANT STAR KEY SETS

Tamper resistant Star Key Sets include the same features as above plus drilled tips that allow use on tamper resistant security screws.

PART #	DESCRIPTION
20401002	Tamper Resistant Star Key Set includes sizes T-6, T-7, T-8, T-9, T-10, T-15, T-20, T-25, T-27 and T-30



BALL TIP HEX KEY SETS

All keys are made of chrome vanadium steel and fold compact for easy storage. Ball tips allow use at up to 30° angle for use in obstructed areas. Holders are made of corrosion resistant aluminum in a slim, compact design.

Inch sizes include: 1/16, 5/64, 3/32, 7/64, 1/8, 9/64, 5/32, 3/16, 7/32 & 1/4"

Metric sizes include: 1.5, 2, 2.5, 3, 4, 5, 6 hex keys and #2 Phillips & 1/4" slotted screwdrivers.

PART #	DESCRIPTION
20300366	Hex Key Set (Inch)
20401021	Hex Key Set (Metric)

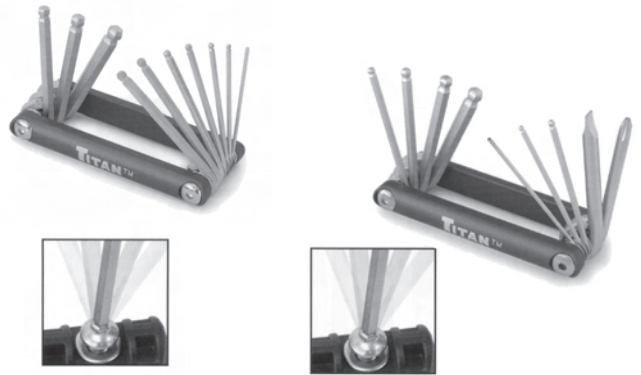

SPANNER DRIVER SET

Kit contains 1 magnetic hand driver with 5 spanner bits in a vinyl pouch. Bit sizes are 6, 8, 10, 12, & 14.

PART # 20300365

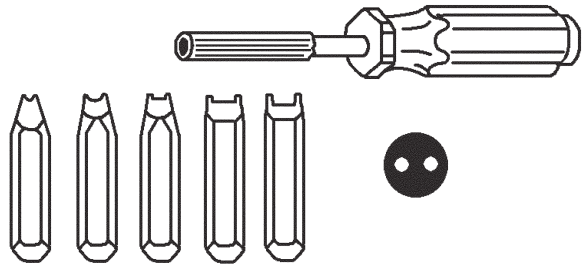

ONE-WAY SCREW REMOVAL TOOLS

PART #	DESCRIPTION
50300225	Removal tool for screw size 4-6-8
50300226	Removal tool for screw size 10-12
50300227	Removal tool for screw size 14, 18, 1/4, 3/8
50300224	Removal tool set, 3 sizes: 6-8, 8-10, 12-14

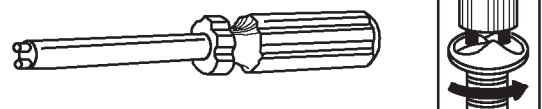

TOOLS, FASTENERS & SEWER EQUIPMENT

NUT DRIVERS

PART #	DESCRIPTION
64360088	Nut driver set. 7 pc 3/16" thru 1/2"
64331184	Extra long 1/4" nut driver
64990018	9/16" nut driver - fits American Standard N-3015 & N-3025 cap

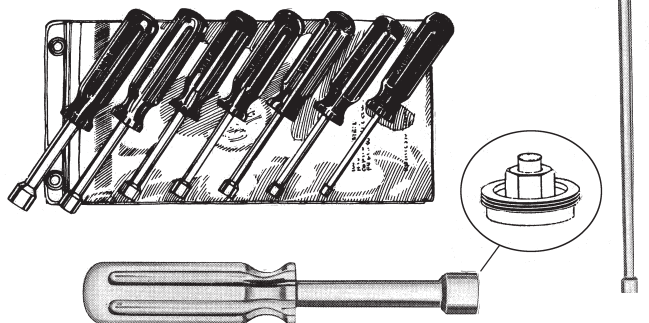

FAUCET SEAT WRENCHES

PART #	DESCRIPTION
64161452	Angle seat wrench, tapered on end (square).
20301410	Angle seat wrench tapered both ends, square & hex.
64161455	Angle seat wrench, six step, 3 hex & 3 square sizes.
20301415	Straight seat wrench, tapered hex & square ends.
20205166	Faucet seat wrench set with ratchet.
20301412	Straight tapered hex end wrench.
20301413	Straight tapered square end wrench.
64321444	Eljer square end wrench- 2 sizes.
20207407	3/8" x 7/16" hex ratchet box wrench.
20301414	Faucet seat wrench set. 4 pieces- 3 hex wrenches 1 tapered square wrench.
64721458	Seat wrench 1/4" hex.
64721460	Seat wrench 5/16" hex.
64721462	Seat wrench 3/8" hex.
20301415	"Shorty" seat wrench
64322300	Seat removal tool

■ = Contents of PART # 64321438

FAUCET SEAT GAUGES/THREAD GAUGES

PART #	DESCRIPTION
20301408	Faucet seat gauge with bibb screw gauge. 20 thread sizes 7/16"-11/16", 4 bibb screw sizes
20301409	Thread gauge. 18 sizes
20401045	Flat seat gauge



20401045

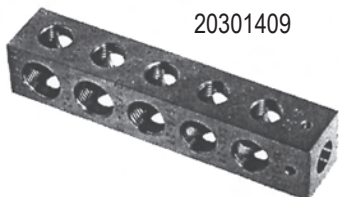

20301409

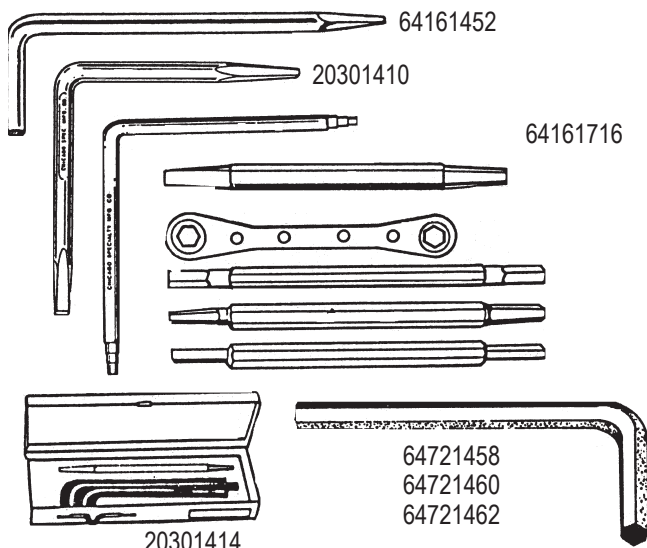
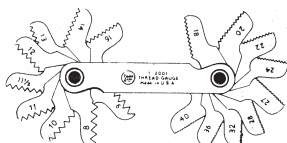

64161452

20301410

64161716

64721458
64721460
64721462

20301414

GLOVES

PART #	DESCRIPTION	PART #	DESCRIPTION
64501099	Leather palm	64501624	Leather elastic cuff
64501100	Leather palm	64501625	Driver's split-leather - L
64501104	Leather palm, cloth back - L	64501626	Driver's split-leather - XL
64501105	Leather palm, cloth back - XL	64501628	Cowhide, pile lining
64501201	Leather palm	64501803	HD Blue rubber - L
64501340	Knit, rubber coated - M	64501804	HD Blue rubber - XL
64501341	Knit, rubber coated - L	64501808	Nitrile coated
64501342	Knit, rubber coated - XL	64501831	Black coating, 12" cuff
64501395	Brown jersey knit	64501834	Black coating, 18" cuff
64501396	White cotton knit	64501853	Black PVC coating
64501601	Driver's leather - L		
64501602	Driver's leather - XL		



64501000



64501395



64501628



64501340



64501601



64501834



**TOTAL
MAINTENANCE
SOLUTIONS**

HOUSTON
800/392-5066

ORLANDO
800/327-3022

GREENVILLE
800/476-2212

LOOK FOR US ON THE WEB AT: www.TMSSouth.com

TOOLS, FASTENERS & SEWER EQUIPMENT

GASKET CUTTER

Allows cutting capacities from 1" to 13" round. Unit contains B-25 blade, K-7 kit of 6 parts (B-17, F-11, P-8, P-9, P-10, P-11), H-7 allen wrench, H-27 handle, L-37 bolt hole locator, D-47 dove-tail designer.

PART #64991010

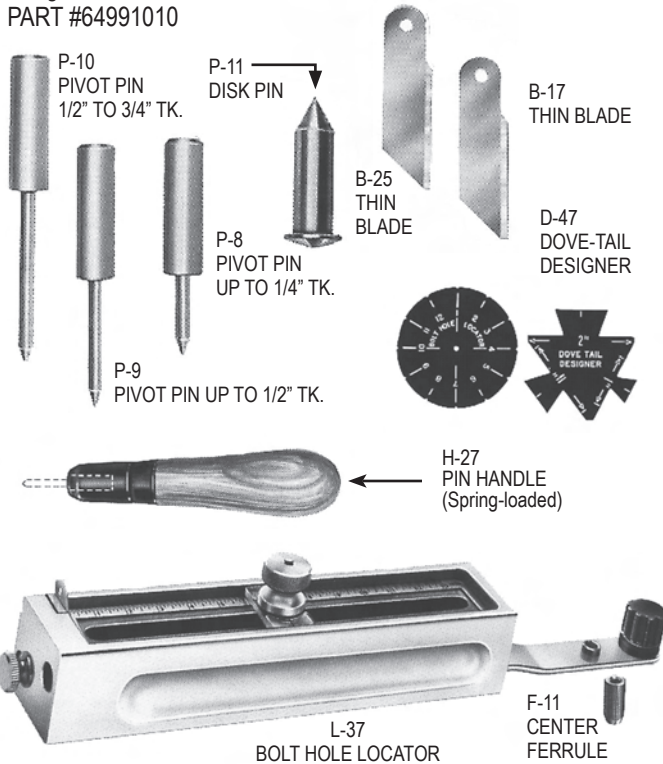

TUBING CUTTER

Cuts polyethylene, polybutylene, PVC, ABS and rubber hose up to 1-1/2" O.D. Cutter does not distort pipe when cutting.

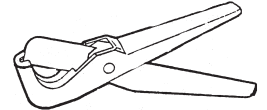

PART #	DESCRIPTION
64001050	Tubing cutter
64001051	Replacement blades (2)
20300369	Ratchet, cuts up to 1"
64361600	Gen. Wire & Cable PVC pipe cutter

GAUGE GLASS CUTTERS

PART #	DESCRIPTION
64009012	For 1/4" thru 3/4" OD gauge glass laboratory glass & porcelain.
64163871	Gauge glass cutter with carbide wheel. Has sliding rule for exact cutting.
64163872	Replacement wheel for gauge glass cutter

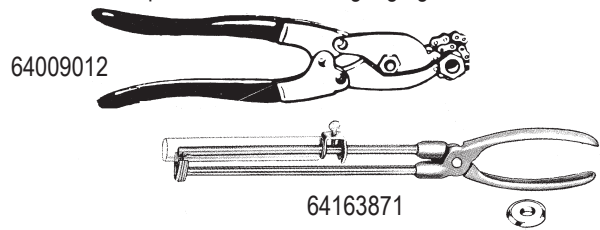

BUCKET BOSS

BUCKET BOSS 44

Made of rugged ripstop fabric. Has an interior loop to keep hammers in place and accessible. Other features include a flapped security pocket, handy tape dispenser loop, two interior pockets for screw bits and other small items. 30 outside pockets and 14 inside pockets! Bucket not included.

PART # 64401044



GATEMOUTH JR.

Ideal for cordless power tools and accessories. Superwide Gatemouth® design. Dimensions are 13" L x 9" W x 8" H.

PART # 64406007



POWER PADS® KNEE PADS

New and improved! These knee pads have an exclusive XL hard-shell cap with 60% more contact area than traditional pads. Features medical grade elastic.

PART # 64402012



PORTABLE POCKET™

Versatile design – carries fasteners or a tape measure. Can be used alone or with a tool belt. Holds nails, screws and other fasteners in its wide opening pouch. Has an elastic loop to hold pens, pencils or a screwdriver.

PART # 64404073

WEB SUSPENDERS

Industrial grade clip suspenders with high quality hardware and a genuine leather cross brace patch.

PART # 64401121

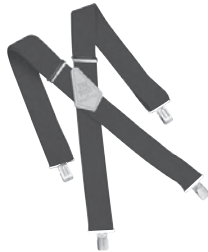

DOUBLE BARREL™ TOOL SHEATH

Made of abrasion resistant material. Stores flashlights, utility knives, small tools and more. Has an elastic channel to hold pens, pencils, etc. 2" stainless steel spring clip holds securely to belt.

PART # 64404041



TOTAL MAINTENANCE SOLUTIONS

HOUSTON
800/392-5066

ORLANDO
800/327-3022

GREENVILLE
800/476-2212

LOOK FOR US ON THE WEB AT: www.TMSSouth.com

TOOLS, FASTENERS & SEWER EQUIPMENT

BENDING SPRINGS

PART #	DESCRIPTION
64161280	3/8" OD bending spring
64161282	1/2" OD bending spring
64161284	5/8" OD bending spring



FITTING/REFRIGERATION BRUSHES

High carbon crimped steel bristles.

PART #	I.D.	PART #	I.D.
93161001	1/4"	20300374	1"
93161002	3/8"	93161010	1-1/4"
20200180	1/2"	93161012	1-1/2"
93161005	1/2" Economy	93161014	2"
20300368	3/4"		
93161007	3/4" Economy		

SEE ALSO PAGES
3-5 AND 18-8



FLARING TOOL

PART #	DESCRIPTION
64161202	Flaring tool. Flares 3/16", 1/4", 5/16", 3/8", 7/16", 1/2", 5/8" OD. For soft copper, aluminum or brass.

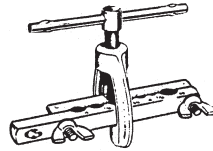

4-WAY COPPER CLEANING TOOL

Brush for cleaning 1/2" & 3/4" Nom. copper inside and out.

PART # 20401020



FLARING TOOL

PART #	DESCRIPTION
64001200	Deluxe flaring tool. Flares 3/16" to 5/16" OD with swing-away flare cone

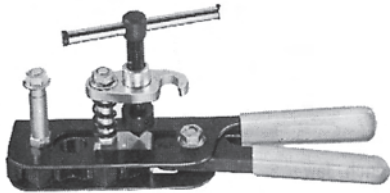

UTILITY TOTE CADDY

Lightweight, durable, high impact plastic

PART # 64000010



SWEDGE TOOLS

PART #	DESCRIPTION
64161210	Swedge tool. Swedges to slip: 3/8", 1/2" & 3/4" ID. Nom sizes to slip 1/2", 5/8", 7/8" OD
20301433	Swedge tool. Swedges: 1/2", 3/4", & 1" ID. Tubing to slip: 5/8", 7/8", 1-1/8" OD



FLARING PUNCHES

PART #	DESCRIPTION
64001202	1/4" Nom. flare punch
64001204	3/8" Nom. flare punch
64001206	1/2" Nom. flare punch
64001208	3/4" Nom. flare punch
64001210	1" Nom. flare punch



25' LIGHTED TAPE MEASURE



- Easy to read in reduced light.
 - Quick read markings
 - Made of high-impact ABS plastic
 - Lock/unlock switch and fingertip friction brake
 - Bubble level
- PART # 64851020

CRIMPING TOOLS

For polybutylene insert plumbing systems. Single size crimping tool comes with Go/No-Go gauge.

PART #	DESCRIPTION
20401047	1/2" CTS tool
20401046	3/4" CTS tool
20401048	Quick Clamp S/S Crimp Ring Tool

64942000

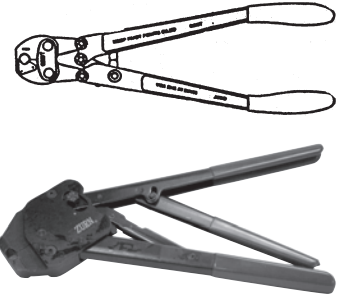

14" LIGHTED LASER LEVEL

- Laser pointer projects a 6mm spot up to 100'
- 3 lighted vials for easy-to-read measurements
- Versatile for most jobs with 0°, 45° and 90° vials.

PART # 64851010



4 PIECE GETTA GRIP TAPE MEASURE SET

- High impact plastic cases
 - Ergonomic handle grips
 - Quick-read markings
- PART # 64851060



SIDECAR KEYRING

PART # 20401004



HOUSTON
800/392-5066

ORLANDO
800/327-3022

GREENVILLE
800/476-2212

LOOK FOR US ON THE WEB AT: www.TMSSouth.com

TOOLS, FASTENERS & SEWER EQUIPMENT

PROPANE TORCHES

PART #	DESCRIPTION
20300363	Self-Lighting torch. Can use both MAPP and propane without changing the orifice. Tip swivels 180 degrees for working in any position.
64960025	Propane torch kit – includes solid brass pencil tip torch and propane cylinder.
20300367	Self-igniting swivel torch. 360° swivel, efficient swirl flame, removable brass tip and solid brass regulator.

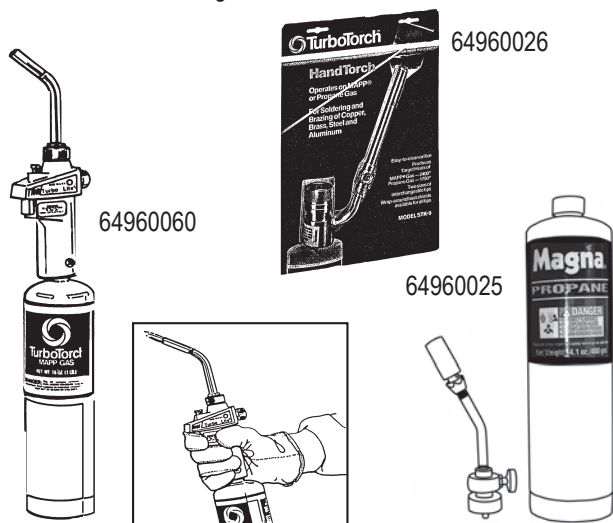

HAND TORCH ACCESSORIES

PART #	DESCRIPTION
64960032	Large torch tip. For 3/8" to 2-1/2" copper
64960030	Small torch tip. For 1/8" to 1/2" copper
64960040	Orifice for 64960032
64960050	Heat shield
64960024	Propane brazing torch (not shown)
64960010	Propane disposable tank 14.1 oz.
20300362	MAPP disposable tank 16.0 oz.
64960054	Single flint cup type striker
64960052	Box of flints (5)
64960058	O-ring for torch tip (6) (not shown)
64960056	Silver brazing (1 lb.). Self fluxing on copper.

Ideal for plumbing, electrical or air conditioning.

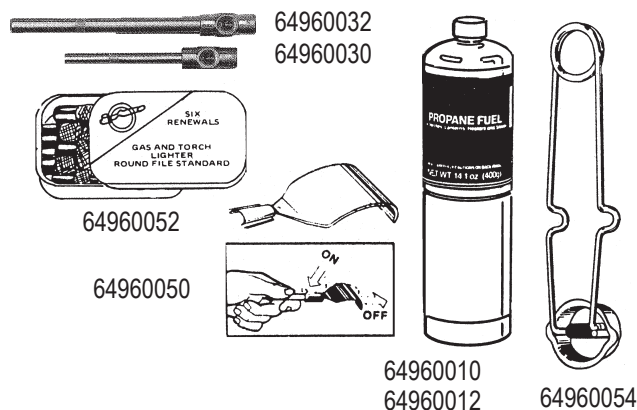

"Jet Swet"™

Original Plumbing Plug

from Brenelle Enterprises, Inc.

PART #	DESCRIPTION
20401049	1/2" – 2" Jet Swet pack w/ case
20401050	1/2" – 1" Jet Swet pack
20401051	1/2" Jet Swet
20401052	3/4" Jet Swet
20401053	1" Jet Swet
20401054	1-1/4" Jet Swet
20401055	1-1/2" Jet Swet
20401056	2" Jet Swet
20401057	2-1/2" Jet Swet
20401058	3" Jet Swet
20401059	4" Jet Swet

REPLACEMENT GASKETS

PART #	DESCRIPTION
20401060	1/2"
20401061	3/4"
20401062	1"
20401063	1-1/4"
20401064	1-1/2"
20401065	2"



HOW TO USE A JET SWET:

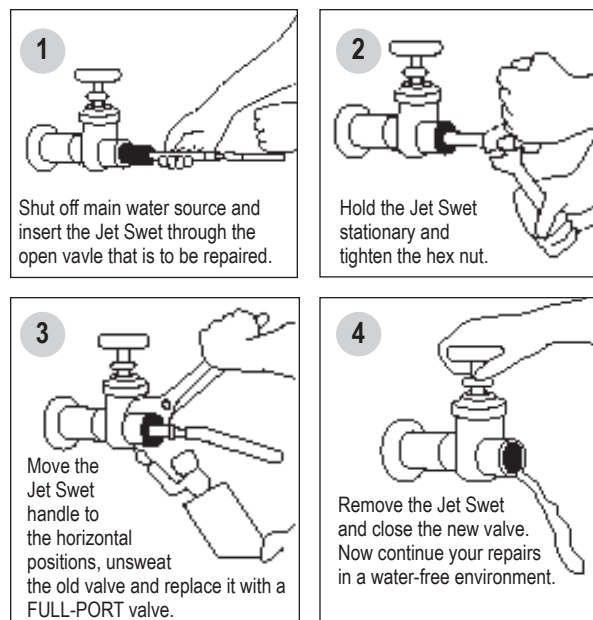

Immediately repair pipes – no waiting for water to drain!
Works with Copper, PVC, ABS, Steel and Black Pipe
Holds up to a maximum 65 psi



**TOTAL
MAINTENANCE
SOLUTIONS**

HOUSTON
800/392-5066

ORLANDO
800/327-3022

GREENVILLE
800/476-2212

LOOK FOR US ON THE WEB AT: www.TMSSouth.com

TOOLS, FASTENERS & SEWER EQUIPMENT

SHEET METAL SCREWS

PAN HD PART #	HEX HD PART #	SIZE	STD BOX
61053290	61053741	6 x 1/2"	100
61053292	61053742	6 x 3/4"	100
61053294	61053743	6 x 1"	100
61053309	61053744	8 x 1/2"	100
61053311	61053745	8 x 3/4"	100
61053312	61053746	8 x 1"	100
61053313	61053747	8 x 1-1/4"	100
61053314	61053748	8 x 1-1/2"	100
61053320	61053750	10 x 1/2"	100
61053321	61053751	10 x 3/4"	100
61053322	61053752	10 x 1"	100
61053323	61053753	10 x 1-1/4"	100
61053324	61053754	10 x 1-1/2"	100
61053326	61053755	10 x 2"	100
61053330	61053756	12 x 1/2"	100
61053331	61053757	12 x 3/4"	100
61053332	61053758	12 x 1"	100
61053333	61053759	12 x 1-1/4"	100
61053334	61053760	12 x 1-1/2"	100
61053335	61053761	12 x 2"	100
61053341	61053762	14 x 3/4"	100
61053342	61053763	14 x 1"	100
61053343	61053764	14 x 1-1/4"	100
61053344	61053765	14 x 1-1/2"	100
61053345	61053766	14 x 2"	100



TOGGLE BOLTS ROUND HEAD-SLOTTED

PART #	SIZE	DRILL SIZE	STD BOX
50300356	1/8"x2"	1/2"	50
50300357	1/8"x3"	1/2"	50
50300358	1/8"x4"	1/2"	50
50300360	3/16"x3"	5/8"	50
50300361	3/16"x4"	5/8"	50
50300364	1/4"x3"	3/4"	50
50300365	1/4"x4"	3/4"	50
50300367	1/4"x6"	3/4"	50
61051160	3/8"x3"	7/8"	25
61051161	3/8"x4"	7/8"	25
61051162	3/8"x6"	7/8"	25

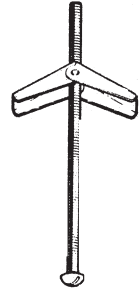

CARBON STEEL TAPER PIPE TAPS

PART #	DESCRIPTION
61083202	1/8"
61083204	1/4"
61083206	3/8"
61083208	1/2"
91083210	3/4"

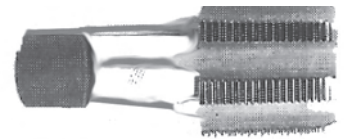

HOLLOW WALL ANCHORS

PART #	SIZE	WALL THK	DRILL SIZE	STD BOX
61051100	1/8 short	1/8-1/2	5/16"	100
61051101	1/8 long	5/8-7/8	5/16"	100
61051106	1/4 short	1/8-5/8	1/2"	50
61051107	1/4 long	5/8-19/16	1/2"	50

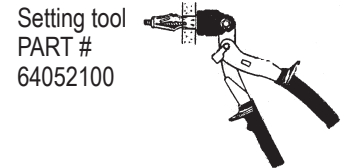
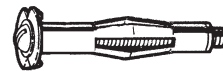

DRIVEN HOLLOW WALL ANCHORS

PART #	SIZE	WALL THK	DRILL SIZE	STD BOX
61051115	1/8 short	3/8	5/16"	100
61051116	1/8 long	5/8	5/16"	100



METAL NAIL ANCHORS (MUSHROOM HEAD)

PART #	SIZE	DRILL SIZE	STD BOX
61051791	1/4"x1"	1/4"	100
61051792	1/4"x1-1/4"	1/4"	100
61051793	1/4"x1-1/2"	1/4"	100



NYLON NAIL ANCHORS (MUSHROOM HEAD) WITH REMOVABLE HEAD

PART #	SIZE	DRILL SIZE	STD BOX
61051062	1/4"x1"	1/4"	100
61051063	1/4"x1-1/2"	1/4"	100
61051064	1/4"x2"	1/4"	100
61051065	1/4"x3"	1/4"	100

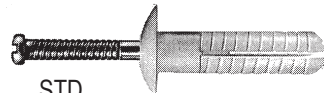

Both metal and nylon anchors available in flat or round head

PLASTIC TOGGLE ANCHORS

PART #	SIZE	DRILL SIZE	STD BOX
61051041	3/8"-1/2"	5/16"	100
61051042	1/2"-5/8"	5/16"	100
61051043	5/8"-3/4"	5/16"	100

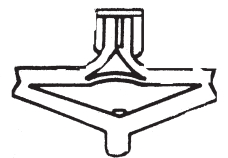

CONICAL PLASTIC ANCHORS

PART #	SIZE	DRILL SIZE	STD BOX
61051029	6-8x3/4"	3/16"	100
61051030	8-10x7/8"	3/16"	100
61051031	10-12x1"	1/4"	100
61051032	14-16x1-1/2"	5/16"	100



TOTAL MAINTENANCE SOLUTIONS

HOUSTON
800/392-5066

ORLANDO
800/327-3022

GREENVILLE
800/476-2212

LOOK FOR US ON THE WEB AT: www.TMSSouth.com

TOOLS, FASTENERS & SEWER EQUIPMENT

105 PIECE SECURITY/STANDARD SCREWDRIVER BIT SET

This complete set includes security bits to remove tamper resistant screws as well as standard bits for more common fasteners: slotted bits, drywall #2 Phillips bits, square drive bits, Hex SAE bits, clutch bits, security Torx bits, security hex bits and spanner bits. Also includes a heavy duty ratchet screwdriver with forward, reverse, and conventional settings; a magnetic extension bit holder and convenient carry case. PART # 20300131



SECURITY-TAMPERPROOF FASTENERS

The following types of Security-Tamperproof fasteners are available

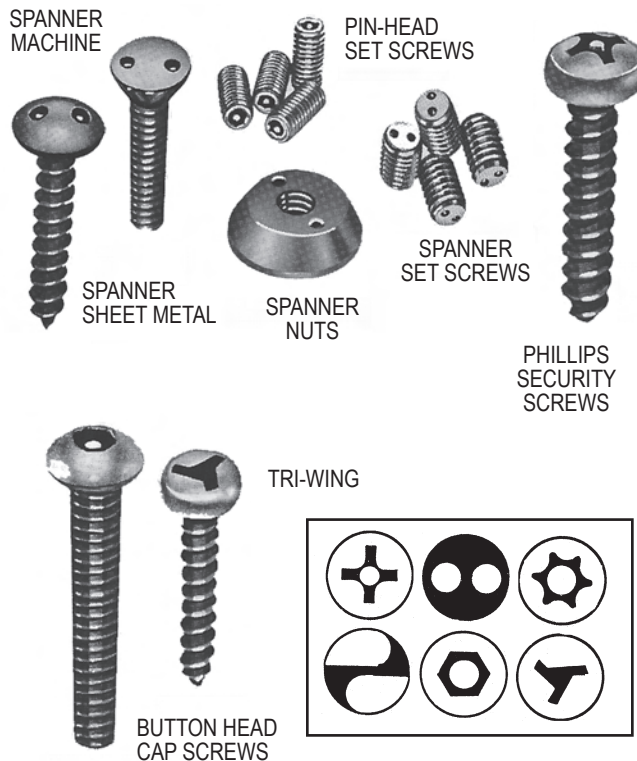

127 PIECE QUICK DISCONNECT BIT SET

Includes:

- 13 high speed steel drill bits, 3 wood boring drill bits, 4 masonry drill bits, 8 brad point bits and 12 nut drivers
 - 48 assorted 2" power screwdriver bits
 - 24 assorted 1" power screwdriver bits
 - 4 hole saws and hole saw mandrel
- PART # 64851050



ONE-WAY FASTENER ASSORTMENTS

- | PART # | DESCRIPTION |
|----------|--|
| 61778012 | One-way tapping screw assortment. Sizes 6 thru 14 zinc & steel plated. |
| 61778014 | One-way combination machine and tapping. Sizes 6, 8, 10, 14; 6-32, 8-32 10-32 and 1/4-20. |
| 61778020 | One-Way sex bolts, door & hardware kit. Contains variations of sex bolts, toilets partition sex bolts, plus one-way door and window hardware screws. |



PAN HEAD SLOTTED TAPPING SCREW KIT

Contains approx. 400 screws No. 4 x 1/2 to No. 10 x 2.

PART # 61000395



ROUND HEAD SLOTTED MACHINE SCREW KIT

Contains approx. 270 screws No. 3/16x1/2 to 1/4x2.

PART # 61000270



FLAT HEAD SLOTTED WOOD SCREW KIT

Contains approx. 325 screws No. 6 x 1/2 to No. 10 x 2.

PART # 61000325



USS FLAT WASHER KIT

Contains 400 washers 3/16 to 3/4. PART # 61000394



TOTAL MAINTENANCE SOLUTIONS

HOUSTON
800/392-5066

ORLANDO
800/327-3022

GREENVILLE
800/476-2212

LOOK FOR US ON THE WEB AT: www.TMSSouth.com

TOOLS, FASTENERS & SEWER EQUIPMENT

SEX BOLT SHOULDERS NUT

Female, threaded 1/4-20
PART # 50400067



ONE-WAY TAPPING SCREWS



PART #	SIZE
77461068	8 x 3/4"
50300167	10 x 5/8"
50300165	10 x 3/4"
50300166	10 x 1"

ONE-WAY SHOULDER SCREWS AND BARREL NUTS

(For toilet partitions and thru-bolt applications)

PART #	SIZE
50300217	10-24 x 15/16" shoulder screw (7/8"-1" panel)
50300219	10-24 x 1-5/16" shoulder screw (1-1/4" panel)
50300222	10-24 x 5/8" barrel nut

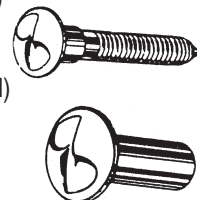

SEX BOLT GROMMET NUT

Female, threaded 1/4-20
PART # 77351080



ONE-WAY MACHINE SCREWS



PART #	SIZE
50300181	8-32 x 3/4"
50300183	8-32 x 1-1/8"
50300186	10-24 x 3/4"
50300228	8-32 button head nut
50300222	10-24 one-way slotted nut

ANCHOR KITS

PART #	DESCRIPTION
61059005	10x1 Combination Phillips/Slotted Pan Head screw kit. Contains 100 anchors & 100 screws with one 1/4" masonry bit.
61059006	14x1-1/2 Slotted Pan Head screw kit. Contains 60 anchors & 60 screws with one 5/16" masonry bit.

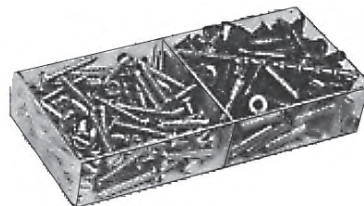

SEE SECTION 5 FOR MORE TOILET PARTITION FASTENERS

ONE WAY OVAL HEAD MACHINE SCREWS

PART #	SIZE
77351072	1/4-20 X 1-3/4"
77351074	1/4-20 X 2"
77351075	1/4-20 X 2-1/4"
77351076	1/4-20 X 2-1/2"



COUNTERSUNK FINISHING WASHER FOR ABOVE SCREWS

PART # 77351078



USE IN: WALL BOARD OR OTHER HOLLOW WALL APPLICATIONS.

USE WITH: #2 or #3 PHILLIPS SCREWDRIVER AND #8 SHEET METAL OR DRY WALL SCREWS.

MADE OF: DuPONT ZYTEL NYLON

SIZE: 3/8" TO 1" WALLBOARD

- Fast and easy to use
- High holding power
- Screw is removable
- Electrically non-conductive for safe installation

PART #	DESCRIPTION
61051199	Box of 100 ZIP-IT plastic anchors
61011199	Zinc, box of 100

ZIP-IT ANCHOR KITS

PART #	DESCRIPTION
61051225	Kit contains the following: 50 Zip-It anchors 50 #8 x 1" screws
61051205	Kit contains the following: 4 Zip-It anchors 4 #8 x 1" screws

ZIP-IT™

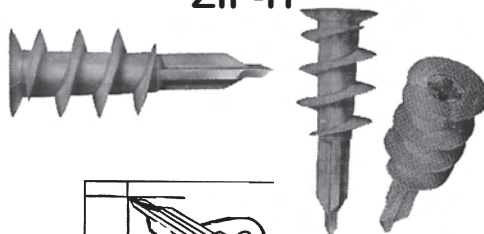

All you need is a #2 or #3 phillips screwdriver

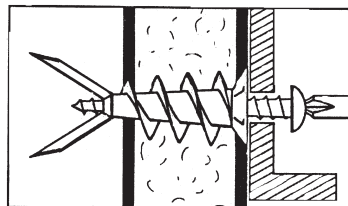

The large collar sets flush to the surface, can't rust and takes paint easily.



ZIP-IT JUNIOR:
Use #6 x 1" screw
61051190

The Zip-It anchors lightweight electrical fixtures to wallboard without drilling

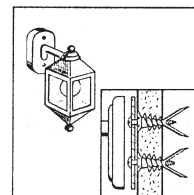

Fixtures are safely anchored to wallboard without cutting hidden cables

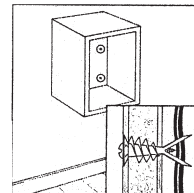

Use Zip-It to quickly fasten drapery supports to wallboard without pre-drilling.

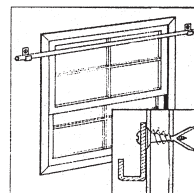

Zip-It is ideal to fasten phone systems and related accessories without special tools

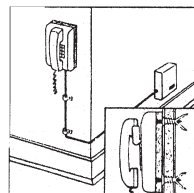

TOTAL MAINTENANCE SOLUTIONS

HOUSTON
800/392-5066

ORLANDO
800/327-3022

GREENVILLE
800/476-2212

LOOK FOR US ON THE WEB AT: www.TMSSouth.com

TOOLS, FASTENERS & SEWER EQUIPMENT

SHOVELS AND SPADES

HOLLOW BACK ROUND POINT BLADE SHOVEL

Stamped from a single piece of steel with forward turned steps for secure and comfortable foot placement. For light to moderate industrial and construction applications.

With 47" fiberglass handle
PART # 20301290

With 27" fiberglass handle
PART # 20301291



HOLLOW BACK SQUARE POINT SHOVEL

With 47" fiberglass handle

PART # 20301309



16" DRAIN SPADE/ SHARP SHOOTER

With 28" fiberglass handle and D-grip

PART # 20301311



SOLID SHANK GARDEN SPADE

Forged from a single bar of steel, the solid neck and blade of this tool is extremely durable. For heavy-duty commercial and contractor use.

With 27" fiberglass blade
PART # 20301308



4" CLASSIC TRENCH SHOVEL

With 48" fiberglass handle

PART # 20301312



POST HOLE DIGGER

With 72" fiberglass handle

PART # 20301310

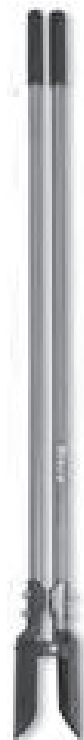

TOTAL MAINTENANCE SOLUTIONS

HOUSTON
800/392-5066

ORLANDO
800/327-3022

GREENVILLE
800/476-2212

LOOK FOR US ON THE WEB AT: www.TMSSouth.com

TOOLS, FASTENERS & SEWER EQUIPMENT

RIDGID TOOLS

PIPE DIES

PART #	NPT
20301316	3/8 - 18
20301317	1/2 - 14
20301318	3/4 - 14
20301319	1 - 11-1/2
20301320	1-1/4 - 11-1/2
20301321	1-1/2 - 11-1/2
20301322	2 - 11-1/2



MODEL 458R RATCHET FLARING TOOL

PART # 20301337



PLASTIC PIPE RATCHET CUTTERS

PART #	DESCRIPTION
20301345	1/8" - 1-1/2" capacity Model 138
20301346	1/8" - 2-3/8" capacity Model 1493
20301358	Model 138 replacement cutter
20301359	Model 1359 replacement cutter



EXPOSED RATCHET THREADER SET, MODEL 00-R

Includes die heads, ratchet assembly, ratchet handle and alloy dies. 1/8" - 1" PART # 20301323



CLOSE QUARTERS TUBING CUTTER

PART #	CAPACITY/MODEL
20301338	1/8" - 5/8", Model 103
20301339	3/16" - 15/16", Model 104

HEAVY-DUTY PIPE CUTTER, 2-A

PART # 20301340



RATCHET AND HANDLE ONLY

PART	DESCRIPTION
20301324	For Model 00-R
20301325	For Model 12-R



TUBING & CONDUIT CUTTERS

PART #	DESCRIPTION
20301341	Screw feed cutter, 1/8" - 1" capacity, Model 10
20301342	Screw feed cutter, 3/16" - 1-1/8" capacity Model 15



DIE HEADS FOR MANUAL THREADERS 00-R AND 12-R



PART #	DESCRIPTION
20301326	For Model 00-R, 3/8" NPT
20301327	For Model 00-R, 1/2" NPT
20301328	For Model 00-R, 3/4" NPT
20301329	For Model 00-R, 1" NPT
20301330	For Model 12-R, 3/8" NPT
20301331	For Model 12-R, 1/2" NPT
20301332	For Model 12-R, 3/4" NPT
20301333	For Model 12-R, 1" NPT
20301334	For Model 12-R, 1-1/4" NPT
20301335	For Model 12-R, 1-1/2" NPT
20301336	For Model 12-R, 2" NPT

CONSTANT SWING CUTTER

Feed cutter, 1/8" - 1-1/8" capacity, Model 150 PART # 20301343



RATCHETING ENCLOSED FEED CUTTER

1/4" - 2-3/8" capacity Model 205 PART # 20401023



REPLACEMENT CUTTER WHEELS

For Tubing	
PART #	FITS MODELS
20301347	154-P, 156-P
20301348	10, 15, 20
20301349	30, 106, 108, 109, 154, 156
20301350	103/104/117, 150, 106, 151-P, 152-P, 153-P, 122
20301351	151, 152, 153, 205
20301352	151-P, 152-P
20301353	106, 108, 109P, 154-P, 156-P
20301354	10, 15, 20

For Pipe	
20301355	1A, 2A, 42A, 202, 360, 820/364, 732
20301356	3S, 4S, 44S, 466C, 466S, 466HWS, 468C, 468S, 468HWS, 472C, 472S 472HWS

NO 127 INNER-OUTER REAMER

1/4" (6mm) through 1-1/2" (37mm) Nominal water tube PART # 20301357



NEED A RIDGID TOOL NOT LISTED HERE?

CALL US! WE'D BE GLAD TO HELP YOU FIND IT!



TOTAL MAINTENANCE SOLUTIONS

HOUSTON
800/392-5066

ORLANDO
800/327-3022

GREENVILLE
800/476-2212

LOOK FOR US ON THE WEB AT: www.TMSSouth.com