

HARDWARE & TOILET PARTITIONS

FLEXIBLE DOOR STOPS

PART #	DESCRIPTION
82000202	3" Steel – aluminum finish economy
50200244	3" Steel – bright brass finish
50200245	3" Steel – bright nickel finish
50200246	4" Steel – bright brass finish
50200247	Replacement tip for flexible stop

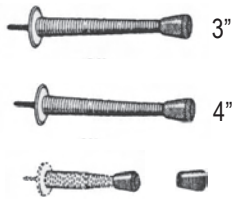

WALL DOOR STOP-ADHESIVE BACKED

PART #	DESCRIPTION
50200020	1-7/8" dia. white adhesive backed resilient bumper
50200005	1-7/8" dia. grey adhesive backed resilient bumper



DOOR STOPS

PART #	DESCRIPTION
50200235	3" aluminum – bright brass finish – economy
50200232	3" aluminum – bright brass finish
50200248	3" aluminum – burnished aluminum
82430206	3-3/4" aluminum – bright brass finish
82430216	4-1/2" aluminum – burnished aluminum finish
50200249	Replacement tip for stops

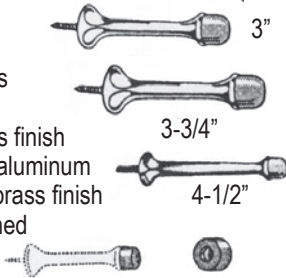

HEAVY DUTY WALL & FLOOR STOPS

PART #	DESCRIPTION
50200030	3-5/8" cast brass wall mtd. stop. Bright chromium finish
50200038	3" high cast brass floor stop. Bright chromium finish
82430803	3" high cast brass floor stop. Dull bronze finish
50200236	2-5/8" high steel-zinc plated finish. For undercut doors
82430415	Bumper only for 82430803

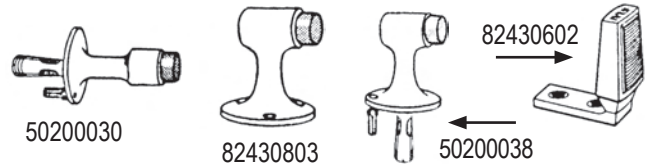

HINGE PIN DOOR STOP

PART #	DESCRIPTION
82430301	1/4" to 5/16" hinge pin. alum. – burnished alum. finish
50200250	1/4" to 5/16" hinge pin. alum. – bright brass finish
50200251	Heavy duty adjusting door stop – bright brass finish

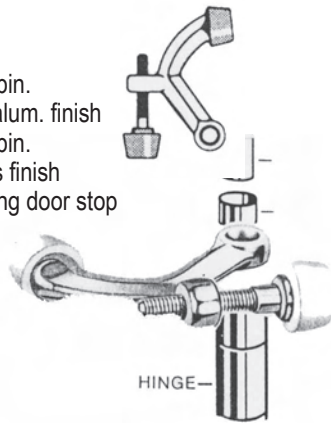

DOMES STOPS & RISERS

PART #	DESCRIPTION
50200008	Dome stop for doors w/o thresholds Cast brass – bright brass finish
50200252	Same as 82430608. Cast brass – dull bronze finish
50200000	Same as 82430608. Cast brass – bright chromium finish
82430604	5/8" Riser for carpeted floors
82430606	1" Riser for carpeted floors

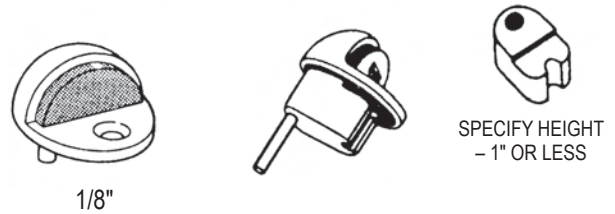

WALL BUMPERS & STOPS

ITEM	PART #	DESCRIPTION
1	50200012	2-1/2" dia. brass – bright brass finish
2	50200004	1" dia. Brass – dull chromium finish
3	50200226	2-1/2" dia. Alum. – alum. satin finish
	50200011	2-1/2" dia. Brass – bright chrome finish
	82430408	Same as 82430406. Comes w/ toggler

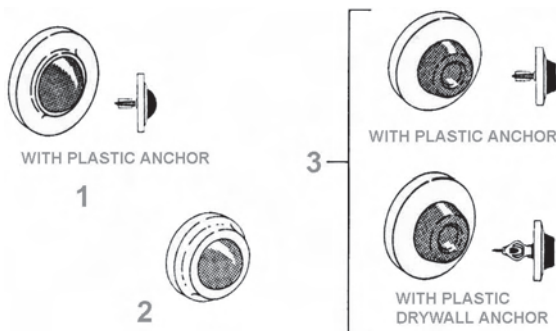

PART #	DESCRIPTION
50200001	Domed stop for doors w/thresholds Aluminum-Aluminum satin finish
50200009	Same as 50200001. Cast brass – bright brass finish
50200254	Same as 50200001. Cast brass – dull bronze finish
50200255	Same as 50200001. Cast brass – bright chromium finish
82430614	5/8" Riser for carpeted floors
50200257	1" Riser for carpeted floors



HOUSTON
800/392-5066

ORLANDO
800/327-3022

GREENVILLE
800/476-2212

LOOK FOR US ON THE WEB AT: www.TMSSouth.com

HARDWARE & TOILET PARTITIONS

KICK-DOWN DOOR HOLDERS

ITEM	PART #	DESCRIPTION
1	50200200	4" Solid brass – dull chromium finish
	82430802	5" Solid brass – dull chromium finish
2	50200194	4" Aluminum – bright brass finish
	50200196	4" Aluminum – burnished alum. finish
	50200258	4" Cast brass – bright brass finish
	82430810	4" Cast brass – bright chromium finish
3	50200197	Replacement tip for kick-down stops
4	50200205	Plunger door stop – aluminum
5	50200207	Plunger door stop – bronze

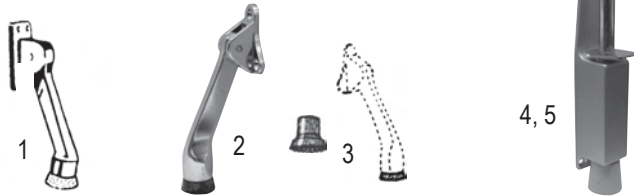

DOOR GUARDS

PART #	DESCRIPTION
50200264	Aluminum – bright chromium finish
50200265	Aluminum – bright brass finish
50200266	Aluminum – antique brass finish

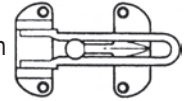

DOOR SILENCER

PART #	DESCRIPTION
50200233	Gray rubber – for metal frames

for metal frames

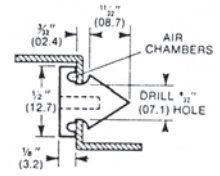

DOOR STOP & HOLDER

PART #	DESCRIPTION
82430340	Cast iron – bright brass finish



MAGNETIC DOOR CATCH

PART #	DESCRIPTION
82431402	Heavy duty Super-Mite catch aluminum – burnished aluminum finish



CHAIN DOOR GUARDS

PART #	DESCRIPTION
50200259	Wrought brass – bright brass finish
82431004	Wrought steel – bright brass finish
50200260	Wrought steel – bright brass finish – economy
50200261	Wrought steel – dull nickel finish

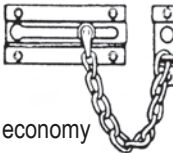

SURFACE & SLIDE BOLTS

ITEM	PART #	DESCRIPTION
1	50200262	3" Surface bolt. Aluminum, aluminum satin finish
	50200263	4" Surface bolt. Cast brass, dull chromium finish
2	82431204	3" Security bolt. Cast brass, bright brass finish

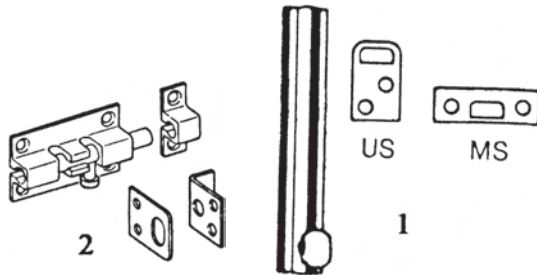

WALL PROTECTOR

PART #	DESCRIPTION
50200238	3" Wall Protector w/ adhesive
50200234	5" Wall Protector w/ adhesive

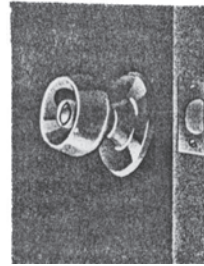

KICK PLATES

PART #	DESCRIPTION
82001050	26" x 7" Lexan kick plate
82431550	30" x 8" Stainless steel
82431560	30" x 8" Aluminum
82431570	30" x 8" Bright brass

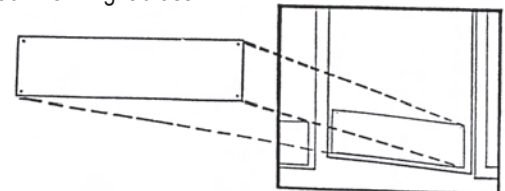

HARDWARE & TOILET PARTITIONS

PUSH/PULL PLATES

PART #	DESCRIPTION
50200108	3-1/2" x 15" Push plate – stainless steel
50200107	3-1/2" x 15" Push plate – aluminum
50200109	3-1/2" x 15" Push plate – bright brass
50200084	3-1/2" x 15" Pull plate - stainless steel
50200083	3-1/2" x 15" Pull plate - aluminum
50200085	3-1/2" x 15" Pull plate – bright brass

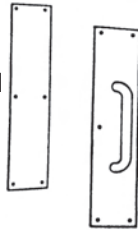

DOOR SAVER – POLISHED BRASS

PART #	DESCRIPTION
82035002	2-3/8" Backset, 1-3/4" thickness – large
82035004	2-3/8" Backset, 1-3/8" thickness – large
82035006	2-3/8" Backset, 1-3/4" thickness – small
82035008	2-3/8" Backset, 1-3/8" thickness – small



DRAPERY HOLD BACK (LEXAN)

PART #	DESCRIPTION
50200268	Drapery hold back – single bend
50200269	Drapery hold back – special bend
82002534	Drapery hold back – double bend

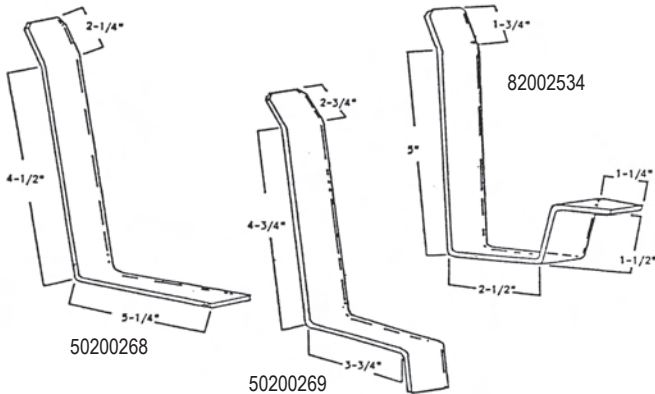

DRAPERY ACCESSORIES

TRAVERSE RODS

PART #	DESCRIPTION
82482514	Regular duty, two-way, traverse rod 28" to 48", projects 2-1/2" to 4-1/4"
82482516	Regular duty, two-way, traverse rod 48" to 84", projects 2-1/2" to 4-1/4"



TRAVERSE SLIDE

PART #	DESCRIPTION
82482504	Celcon – Traverse slide – Kirsch
82342508	White – Traverse slide – Graber

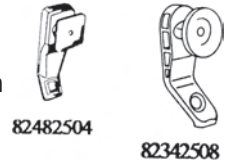

TRAVERSE ROD ACCESSORIES

PART #	DESCRIPTION
82482505	One-way master slide, left or right
50200270	Reversible master slide for one-way draw
82482507	End cap
82482510	Insert pulley & cap – for Kirsch 9000
50200271	Plastic cord tension pulley
50200272	1/8" x 500 ft. nylon drapery cord
82482519	White plastic cord drop
82482517	Curtain hook-For 3-1/2" open heading
50200273	Decorative rods only
50200273	Heavy duty offset pin-on hook

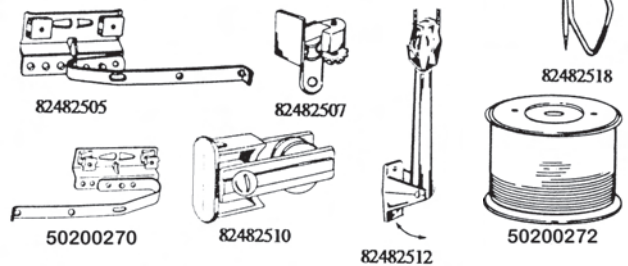

CORNER GUARDS

PART #	DESCRIPTION
40500062	1" x 1" x 48" Lexan plastic
80106010	3-1/2" x 3-1/2" x 40" stainless steel
40500069	3-1/2" x 3-1/2" x 48" stainless steel
40500060	3/4" x 3/4" x 48" Lexan plastic
40500061	3/4" x 3/4" x 96" Lexan plastic

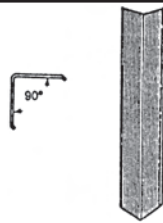

BATONS & ACCESSORIES

PART #	DESCRIPTION
50200274	1/4" dia. fiberglass baton – 30" long
50200275	3/8" dia. fiberglass baton – 36" long
50200276	Baton fastener
50200277	Baton screw

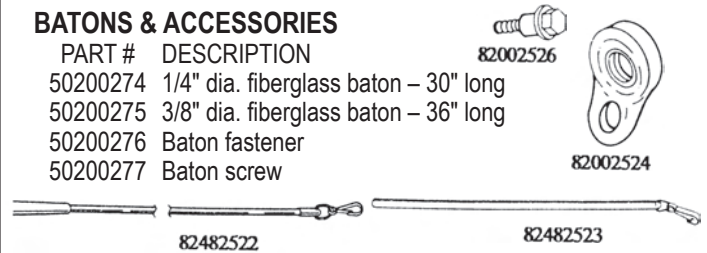

ENERGY GUARD

Air control system for motels, hospitals, nursing homes and other applications. Compatible with all tip vented heat pumps. Installs with four #6 self tapping screws. Made of clear Lexan.

PART # 82001070

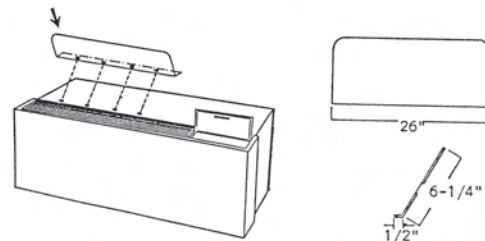

**TOTAL
MAINTENANCE
SOLUTIONS**

HOUSTON
800/392-5066

ORLANDO
800/327-3022

GREENVILLE
800/476-2212

LOOK FOR US ON THE WEB AT: www.TMSSouth.com

HARDWARE & TOILET PARTITIONS

INDIVIDUAL COMPONENTS

If you need to replace a damaged component on your existing partitions, TMS SOUTH can supply these in baked enamel steel, stainless steel, plastic laminate, solid plastic or phenolic. Request our product guide to match colors with your existing partitions.

DOORS

Please specify the actual door size i.e. 23-1/2" x 58" and thickness or the actual door opening i.e. 24". Also specify the material and whether the door is inswing or outswing. All doors are shipped with mounting hardware.

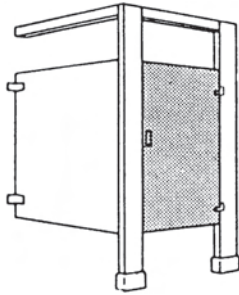

PANELS

Please specify the actual panels size and thickness (i.e. 54-1/2" x 58" x 1"). Also specify the material. Panels come with hardware to mount them to the wall and pilasters.

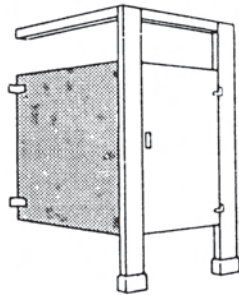

PILASTERS

Please specify the width, length and thickness of the pilaster. For floor mounted pilasters with headrail indicate whether the headrail slips over or into the pilaster. Pilasters come with hardware to mount them to the floor or ceiling and a pilaster shoe.

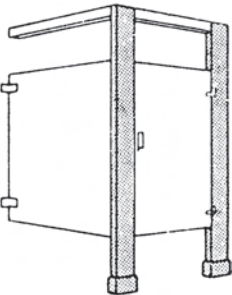

HEADRAIL

Specify the type of headrail and length required. Any length over 100" cannot be shipped by UPS.

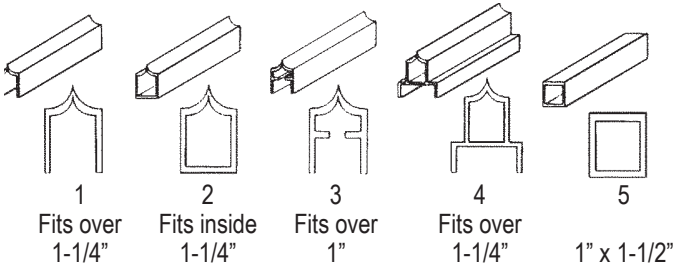

PILASTER SHOES

Please specify if shoe is for floor or ceiling hung pilaster and the type of material it is used on i.e. baked enamel. Mounting hardware is ordered separately

TYPE A	TYPE B	SIZE
PART #	PART #	
50400333	77462080	2"
50400305	77462082	3"
50400291	77462084	4"
50400298		5"
50400306	77462088	6"
50400308	77462090	8"
50400310	77462092	10"
50400311	77462094	12"
50400038	77462096	14"
77461098	77462098	18"
77461099	77462099	24"

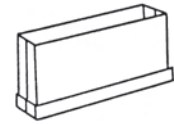

Type A
For 1-1/4" Sq. edge pilasters

Type B
For 1-1/4" round edge pilasters

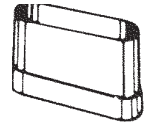

Open type (one-end) also available (specify)

GRAB BAR - SAFETY BARS



All grab bars are 304 stainless steel (18 gauge). All 1-1/4" and 1-1/2" grab bars are produced to satisfy the handicap code for State and Federal requirements. Check with your local code authority concerning use of 1-1/4" or 1-1/2" diameter bars. These bars meet ANSI A117.1. All bars listed below come with standard finish. Peened finishes are available.

1-1/4" EXP. MTNG. PART #	1-1/2" CON. MTNG. PART #	BAR LENGTH
80772330	80774330	18"
80772332	80774332	24"
80772338	80774338	36"
80772340	80774340	42"



EXPOSED MOUNTING



CONCEALED MOUNTING

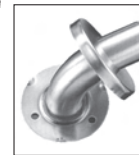

Snap Flange

STAINLESS STEEL GRAB BARS – SNAP FLANGE

PART #	DESCRIPTION
80775718	1-1/4" x 18" Chrome grab bar
80775720	1-1/4" x 18" White grab bar
50200278	1-1/4" x 24" White grab bar
40500140	1-1/2" x 18" Stainless steel grab bar
40500135	1-1/2" x 24" Stainless steel grab bar
50200279	1-1/2" x 30" Stainless steel grab bar
80775332	1-1/2" x 32" Stainless steel grab bar
40500116	1-1/2" x 36" Stainless steel grab bar
40500117	1-1/2" x 42" Stainless steel grab bar
50200280	1-1/2" x 48" Stainless steel grab bar

REFER TO PAGE 5-20 FOR INFORMATION ABOUT SPECIALTY GRAB BARS



TOTAL MAINTENANCE SOLUTIONS

HOUSTON
800/392-5066

ORLANDO
800/327-3022

GREENVILLE
800/476-2212

LOOK FOR US ON THE WEB AT: www.TMSSouth.com

HARDWARE & TOILET PARTITIONS

TWO EAR WALL BRACKET

PANEL SIZE	CHROME ZAMAK PART #	S/S STAMPING PART #	ALUM. EXTRUSIONS PART #
1/2"		77461433	
3/4"	77462002	77461533	77774034
7/8"	50200296		
1"	50400042	77461753	50200282
1" (1)	50400043		50200283
1-1/4"	50400044		

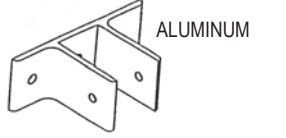
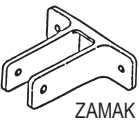

(1) Extra long bracket 3-1/2"

TWO PIECE BRACKET

CHROME ZAMAK
PART # 50400040

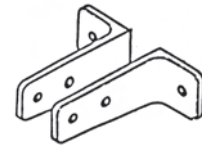

URINAL SCREEN BRACKET

CHROME ZAMAK

PART #	PANEL THICK.	BRACKET LENGTH
50400068	1"	3-1/2"
50400036	1"	12"
50400037	1-1/4"	6"

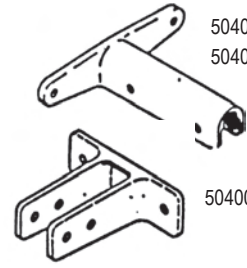

50400036
50400037

50400068

ONE EAR WALL BRACKET

PANEL SIZE	CHROME ZAMAK PART #	S/S STAMPING PART #	ALUM. EXTRUSIONS PART #
1/2"		77461463	
3/4"	50200299	77461563	77774035
7/8"	50200300		
1"	50400047	77631016	50200284
1-1/4"	50400048	77461843	50200285

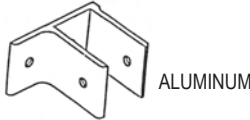
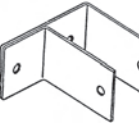
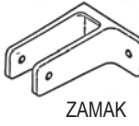

HEADRAIL WALL FITTING

HEADRAIL SIZE	CHROME ZAMAK PART #	S/S STAMPING PART #
1"	50400041	77462169
1-1/4"	50400051	

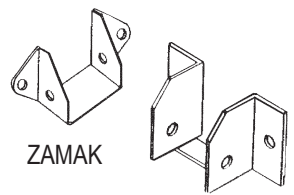

S/S STAMPING

ALCOVE CLIPS

PART #	DESCRIPTION
50200305	1 (pr) clips for joining 1" panels to 1-1/4" pilasters
50400365	Curved molding (fits at top & bottom and joins to 1-1/4" pilaster)

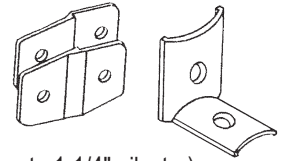

U-BRACKET

PANEL SIZE	CHROME ZAMAK PART #	S/S STAMPING PART #	ALUM. EXTRUSION PART #
1/2"		77461943	
3/4"	50200302	77461953	
7/8"	50200303		
1"	50400050	77461913	77775007
1-1/4"	50200304		

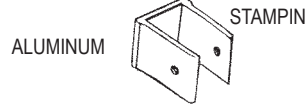
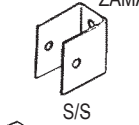
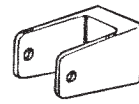

HEADRAIL END CAPS

PART #	DESCRIPTION
77466670	Headrail end cap for type 4 headrail
77201050	Headrail end cap for type 3 headrail
77260088	Headrail end cap for type 1 headrail

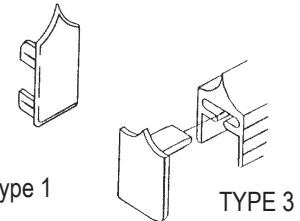

TYPE 3

CONTINUOUS WALL BRACKETS - EXTRUDED ALUMINUM FOR PARTITIONS WITH 58" HIGH PANELS

PART #	DESCRIPTION
77462344	1" x 57-1/2" Two ear
77462345	1" x 41-1/2" Two ear
77462334	1" x 57-1/2" One ear
77462354	1-1/4" x 57-1/2" One ear

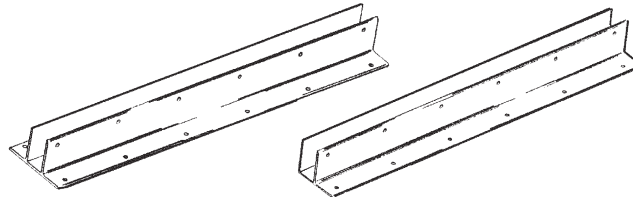

CONTINUOUS WALL BRACKETS FOR SOLID PLASTIC PARTITIONS WITH 55" HIGH PANELS

DESCRIPTION	ALUM	WHITE	BEIGE	GREY	BLUE	BRN.	BLK	TEAL
1" x 54" Two ear	50400052	77201008	77201010	77201012	77201014	77201016	77201018	77201020
1" x 54" One ear	77201002	77201022	77201024	77201026	77201028	77201030	77201032	77201034
1" x 54" "H" Brkt.	77201004	77201036	77201038	77201040	77201042	77201044	77201046	77201048



TOTAL MAINTENANCE SOLUTIONS

HOUSTON
800/392-5066

ORLANDO
800/327-3022

GREENVILLE
800/476-2212

LOOK FOR US ON THE WEB AT: www.TMSSouth.com

HARDWARE & TOILET PARTITIONS

TORX HEAD SHOULDER SCREW & BARREL NUTS (10-24)

PART #	M	F	DESCRIPTION
50300384	15/16"		CP steel with center pin
50300385	3/4"		S/S with center pin
50300386	1-5/16"		CP steel with center pin
50300387	15/16"		CP steel without center pin
50300388	1-5/16"		CP steel without center pin
50300389		5/8"	CP steel with center pin
50300390		5/8"	CP steel without center pin
50300391		3/4"	S/S with center pin

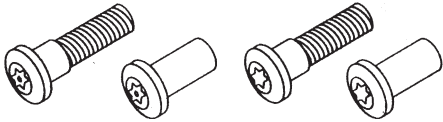

TORX HEAD SECURITY SCREWS

PART #	SIZE	DESCRIPTION
50300392	#14 x 5/8"	Chrome plated steel without center pin
50300393	#14 x 3/4"	S/S with center pin

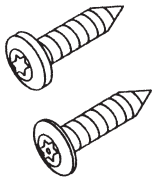

50300394 Torx bit – for screws with center pin



ONE-WAY SHEET METAL SCREWS

PART #	DESCRIPTION	USE
77461068	#8 x 3/4" self tapping screw	Coat Hook
50300167	#10 x 5/8" self tapping screw	Slide Latch
50300165	#10 x 3/4" self tapping screw	Slide Latch
50300166	#10 x 1" self tapping screw	Flat back strike
77469233	#12 x 1-1/2" self tapping screw	Bracket to Wall
50300404	#14 x 5/8" self tapping screw	Bracket to Panel or Pilaster



MALE SHOULDER SCREWS & FEMALE BARREL NUTS (10-24)

PART #	M	F
50300403	1/2"	
50300217	15/16"	
50300219	1-5/16"	
50300221		1/2"
50300222		5/8"

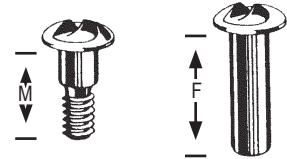

M	+	F	=	P
1/2"		1/2"		3/4"
15/16"		5/8"		1"
1-5/16"		5/8"		1-1/4"

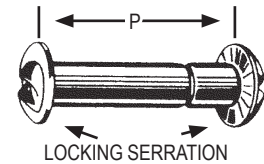

STAMPED S/S FOR SQUARE POSTS

Please specify door size (thickness)

 INSWING Specify door thickness	 OUTSWING Specify post size	 INSWING For 3/4" doors	 INSWING Specify door thickness
 INSWING STRIKE Specify door thickness Keeper	 OUTSWING STRIKE & KEEPER Specify door thickness	 STRIKE for any size. KEEPER for IN or OUTSWING	 INSWING LATCH & STRIKE COMBO Can be used if door and post are equal

INSWING STRIKE & KEEPER - S/S FOR SANYMETAL

PART # 7777269
For 3/4" doors

PART # 7777270
For 1" doors

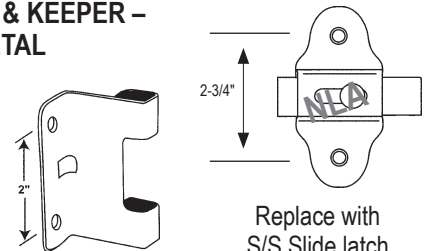

Replace with S/S Slide latch

MACHINE SCREWS & FEMALE BUTTONS (8-32)

PART #	M	F
50300181	3/4"	
50300183	1-1/8"	
50300228		1/2"

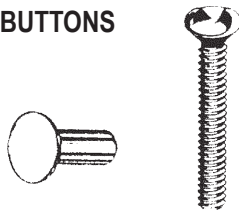

ONE - WAY SCREW REMOVAL TOOLS

PART #	DESCRIPTION
50300225	Removal tool fits screw sizes 4-6-8
50300226	Removal tool fits screw sizes 10-12
50300227	Removal tool fits screw sizes 14,18,1/4,3/8
50300224	Removal tool kit (3 sizes) - Fits all sizes

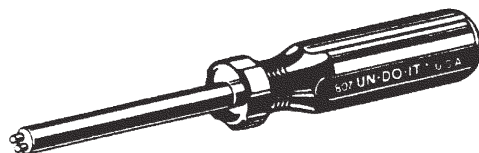
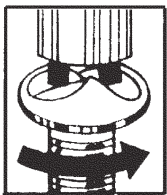

HOUSTON
800/392-5066

ORLANDO
800/327-3022

GREENVILLE
800/476-2212





LOOK FOR US ON THE WEB AT: www.TMSSouth.com



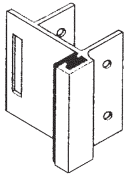
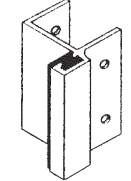
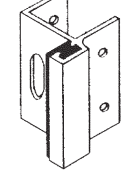
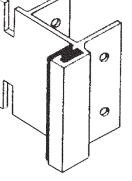
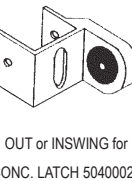

HARDWARE & TOILET PARTITIONS

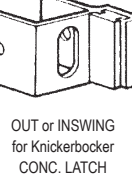
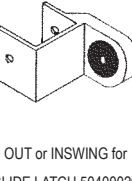
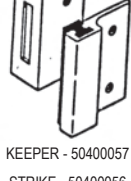
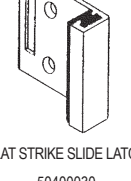
STRIKE & KEEPERS FOR SQUARE EDGE (1-1/4") POST (Plastic Laminate)

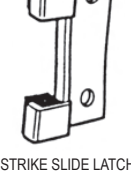
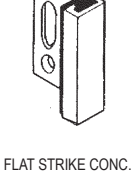
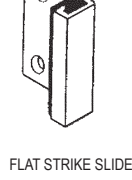
COAT HOOKS & BUMPERS

A = distance between screw holes

 INSWING 50400233	 OUTSWING 50400236	 OUT or INSWING for CON. LATCH 50400239	 INSWING for THROW LATCH 77465130
 OUT or INSWING for CONC. LATCH 50400027	 INSWING for THROW LATCH 50400028	 OUT or INSWING for Sany- metal CONC. LATCH 7775052	 OUT or INSWING for Knickerbocker CONC. LATCH 77461152
 OUT or INSWING for SLIDE LATCH 50400026	 KEEPER - 50400057 STRIKE - 50400056	 FLAT STRIKE SLIDE LATCH 50400030	 KEEPER - 504000231 STRIKE - 50400056
 KEEPER SLIDE LATCH Sanymetal 50400035	 STRIKE SLIDE LATCH Sanymetal 50400034	 FLAT STRIKE CONC. LATCH 50400031	 FLAT STRIKE SLIDE LATCH 50400029

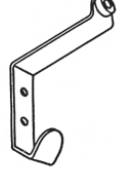
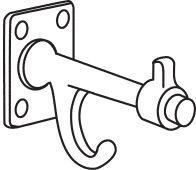
 TWO PRONG HOOK Pol. Brass - 77461030 Chrome - 50400244	 DOOR STOP 50400241	 COAT HOOK and BUMPER Sanymetal 50400243
 COAT HOOK and BUMPER 50400240 BUMPER ONLY 77461029	 COAT HOOK and BUMPER 50400251	 S/S HOOK & BUMPER 50400246
 CLOTHES HOOK AND BUMPER BOBRICK 77101010		

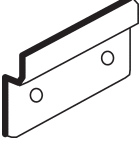
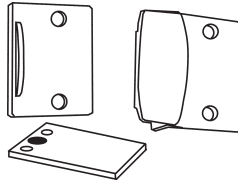
 Bobrick INSWING KEEPER 77101004	<p>PART # 77462350 For Global or Accurate</p> 
--	---

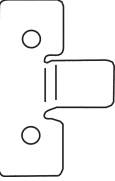
 Bobrick OUTSWING KEEPER 77101006	<p>IF YOU'RE UNSURE ABOUT WHICH PARTS YOU NEED... CALL US, WE'D BE GLAD TO HELP!</p>
--	---

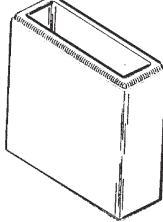
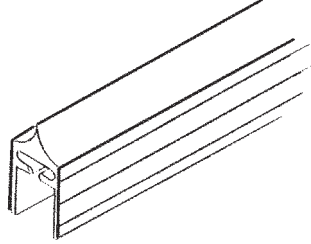
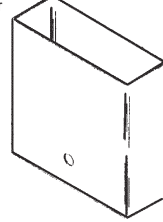
<p>Plastic pilaster shoes Order by size & color.</p> 	<p>HEAD RAIL FOR 1" SOLID PLASTIC PILASTERS</p> <p>Heavy Duty Aluminum headrail Order by the foot.</p> 
<p>Stainless steel pilaster shoes. Order by size.</p> 	

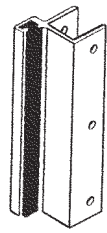
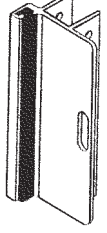
 OS Strike & Keeper 77501012 6" Aluminum	 IS Strike & Keeper 77501014 6" Aluminum
--	---



**TOTAL
MAINTENANCE
SOLUTIONS**

HOUSTON
800/392-5066



ORLANDO
800/327-3022

GREENVILLE
800/476-2212

LOOK FOR US ON THE WEB AT: www.TMSSouth.com

HARDWARE & TOILET PARTITIONS

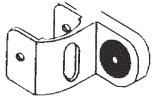
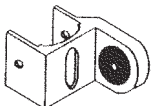
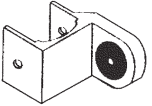
STRIKE & KEEPERS FOR ROUND EDGE (1-1/4") POST (Baked Enamel Steel)

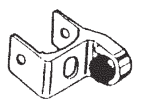
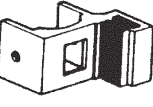
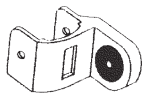
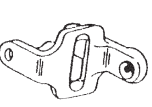
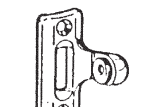
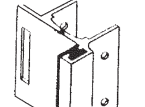
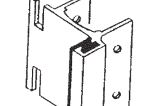
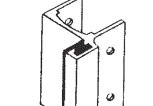
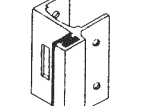
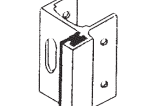
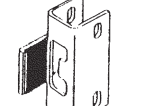
				
OUT or INSWING for CONC. LATCH with round bar 50400024	IN or OUTSWING for CONC. LATCH 50200236	OUTSWING for SLIDE LATCH 50400026	NO LONGER AVAILABLE USE 50400024 OUT or INSWING TOGGLE TYPE Sanymetal 77775018	OUT or INSWING for CONC. LATCH Sanymetal 77775046
				
OUT or INSWING for CONC. LATCH Knickerbocker 50200286	OUT or INSWING for CONC. LATCH with FLAT TIP 50400033	STRIKE & KEEPER Mills 77630318	STRIKE & KEEPER Mills 50400025	INSWING for SLIDE LATCH 50400232
				
INSWING for THROW LATCH 50400234	OUTSWING for SLIDE LATCH 50400235	IN or OUTSWING for CONC. LATCH w/ flat bar 50200307	IN or OUTSWING for CONC. LATCH w/ round bar 77465430	STRIKE & KEEPER Weis/Robart 77990136

HARDWARE FOR SOLID PLASTIC PARTITIONS

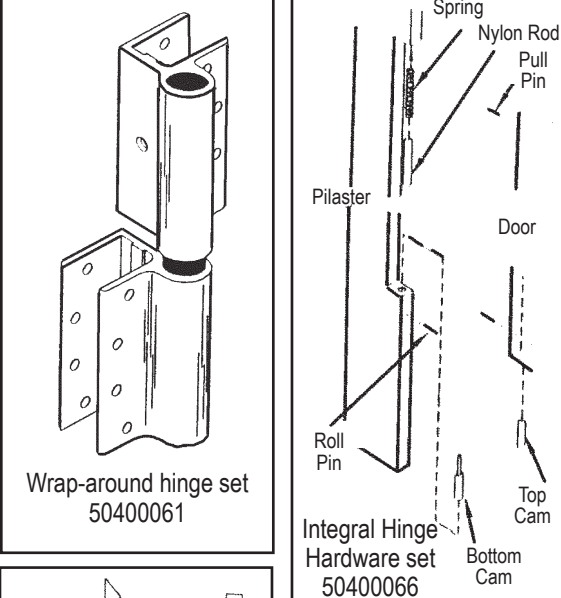

Wrap-around hinge set
50400061

Integral Hinge Hardware set
50400066

Labels: Spring, Nylon Rod, Pull Pin, Pilaster, Door, Roll Pin, Top Cam, Bottom Cam

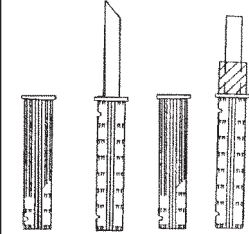

Hinge insert (8")
Top - 77009000
Pivot
Hinge insert (8")
Bottom - 77009001
Non-pivot

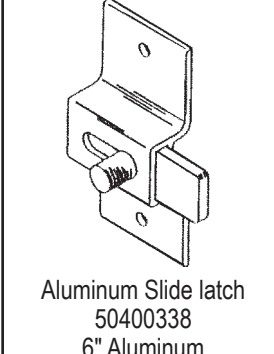

Aluminum Slide latch
50400338
6" Aluminum

DOOR PULLS

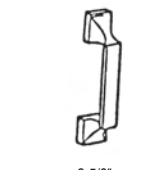
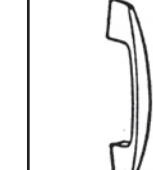
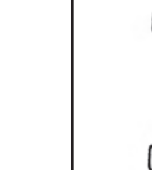
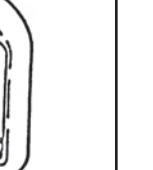
			
2-5/8" BETWEEN SCREWS Sanymetal 77775030	2-3/4" BETWEEN SCREWS 50400248	3-1/2" BETWEEN SCREWS 50400249	4" BETWEEN SCREWS Knickerbocker 77466240

CONTINUOUS HINGES FOR ANY TOILET STALL INSTALLATION

FULL SURFACE GEARED HINGES FROM SELECT PRODUCTS

SELECT SL60 AND SL62
FULL SURFACE, CONTINUOUS GEARED HINGE

- Bonds pilaster and door into one continuous unit
- Door "kick-back" shock dissipates along entire hinge length
- Compensates for warped or irregular doors and frames
- Quick, easy installation
- One-way, slotted, chrome-finished barrel nuts and shoulder screws
- System is:
 - tamper-proof
 - rust-proof
 - maintenance free
- Use with all types of partition applications

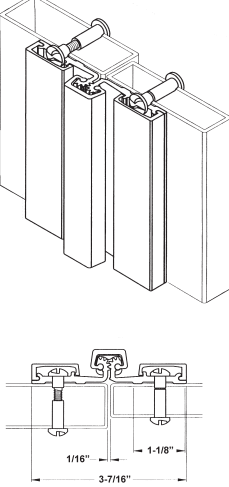

FULL SURFACE SPRING LOADED HINGES FROM MARKAR PRODUCTS, INC.

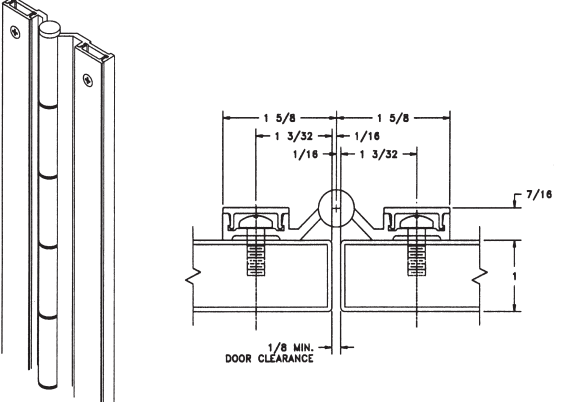

Dimensions: 1 5/8, 1 3/32, 1/16, 1 1/8, 1 3/32, 7/16, 1/8 MIN. DOOR CLEARANCE



TOTAL MAINTENANCE SOLUTIONS

HOUSTON
800/392-5066

ORLANDO
800/327-3022

GREENVILLE
800/476-2212

LOOK FOR US ON THE WEB AT: www.TMSSouth.com

HARDWARE & TOILET PARTITIONS

GRAVITY PIVOT HINGES FOR SQUARE POST (1-1/4")

TYPE	TOP HINGE	BOTTOM HINGE	DIMEN. "A"	DIMEN. "B"	PIN	BUSH.	PINTLE	CAM
A	77463610	77463110	1.125		77469585	77469095	77000012	77462010
A	77463620	77463120	1.155		50400227	77469060	50400293	
B	77000211	77000214	1.275	1.5	50400255		50400293	77468185
C	50400355	50400356	1.385	1.125	50400260	77469062	50400293	77269000
A	77463930	77463430	1.104	1.5	50400227	77469060	77631014	
D	50200287	50200288	1.125	1.25	50200289		50200293	
E	77464020	77464022	1.385	1.125	50400260	77469062	50400293	77269000
F	77461026	77461022	1.313	1.5	50400262	77469060	77000012	77462010
G	77005175	77005280	1.265	1.5	50400262	77469060	77260311	
H	77011610	77011610	1.3	1.5	77011173			
I	50200291	50200292			77301400		77301600	77301700

HINGE IDENTIFICATION

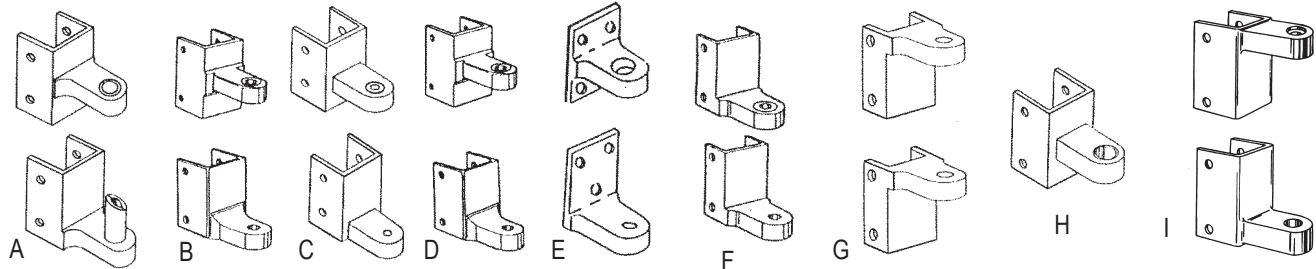
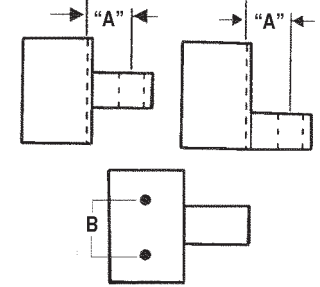

GRAVITY PIVOT HINGES FOR ROUND POST (1-1/4")

TYPE	TOP HINGE	BOTTOM HINGE	DIMEN. "A"	DIMEN. "B"	PIN	BUSH.	PINTLE	CAM
A	50400279	50400280	1.187	1.5	50400262	77469060		
B	50400288	50400289	1.104	1.5	50400227	77469060	77467245	
C	50400284	50400283	1.385	1.125	50400260	77469062	77467245	
D	50400277	50400278	1.165	1.25	50200289		50400274	
E	KIT	50400285		1.375	INCLUDED	INCLUDED	INCLUDED	
F	77001820	77001810	1.187	1.5	-	-	77011806	77011807
G	77002300	77002300		1.375	-	-	77005000	-
H	50400359	50400360			77301400		77301600	77301700
I	50400361	50400362			77301400		77301600	77301700

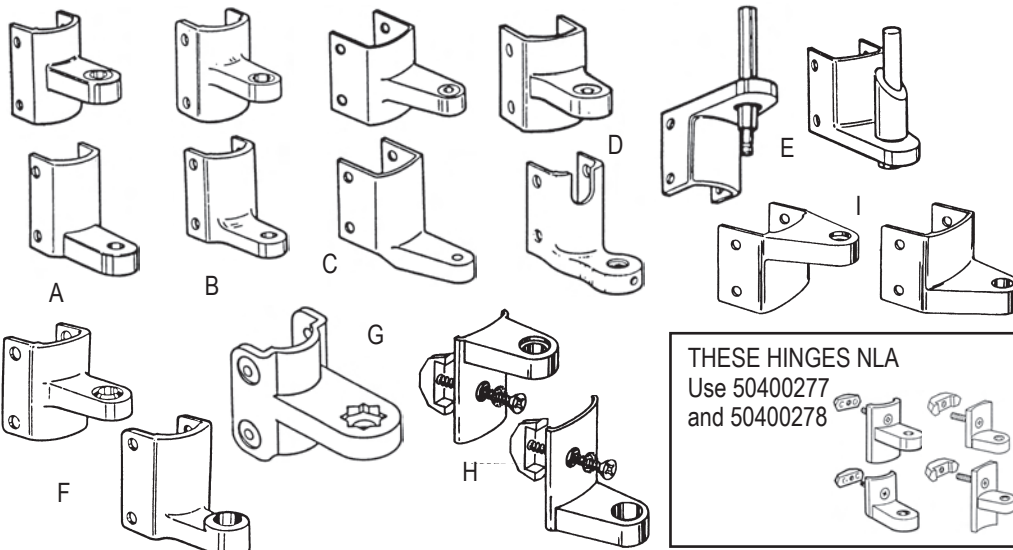
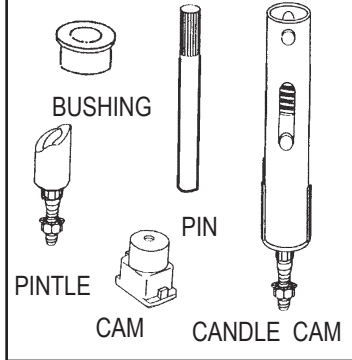

DISCONTINUED HINGES

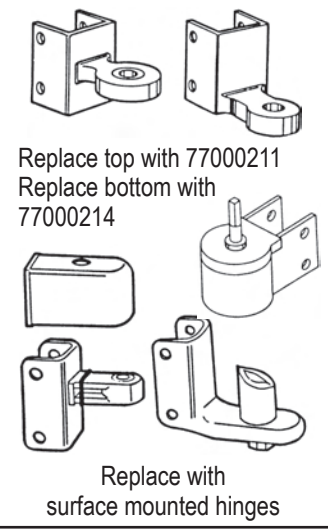

**TOTAL
MAINTENANCE
SOLUTIONS**

HOUSTON
800/392-5066

ORLANDO
800/327-3022

GREENVILLE
800/476-2212

LOOK FOR US ON THE WEB AT: www.TMSSouth.com

HARDWARE & TOILET PARTITIONS

SURFACE MOUNTED HINGES

SURFACE MOUNTED HINGE PAIR

1-1/2" Vertical & 2-3/8" Horizontal between screws

RH-IN or LH-OUT 50400270
RH-OUT or LH-IN 50400271
Hinges are chrome plated brass

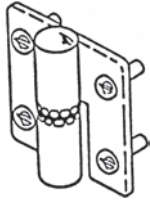

SURFACE MOUNTED HINGE PAIR

LH-IN or RH-OUT 50400266
RH-IN or LH-OUT 50400265
Hinges are cast stainless steel

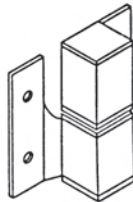

SURFACE MOUNTED HINGE PAIR

LH-IN or RH-OUT 50400269
RH-IN or LH-OUT 50400268
Hinges are cast stainless steel

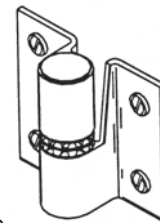

DOOR SWING

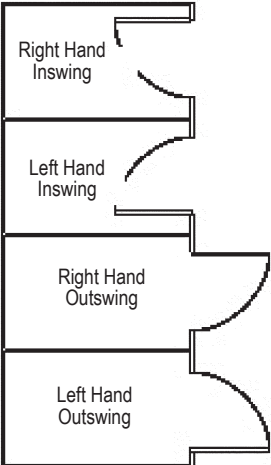

STAINLESS STEEL CONTINUOUS PIANO HINGES

RH-IN or LH-OUT 50200308
LH-IN or RH-OUT 50200309

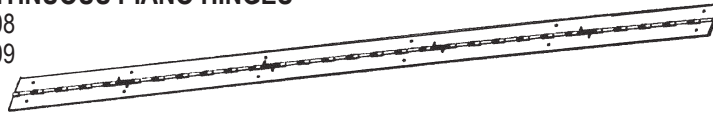

DOOR INSERTS FOR 1" DOORS

TYPE	TOP INSERT	DIMEN. "A"	DIMEN. "B"	BOTTOM INSERT	DIMEN. "A"	DIMEN. "B"	PIN	PINTLE	CAM
A	50200311	2-5/16"	1-5/8"	50200312	2-1/4"	1-1/8"	50400262	50400293	50400069
B	77001510	2"	1-1/4"	77002900	1-13/16"		50400262	77000012	77462010
C	77011620	2-1/4"	2-1/8"	77011620	2-1/4"	2-1/8"	77011173		77011635
D	77001510	2-1/8"	1-9/16"	77350240	2-1/8"	3/4"	77469574	77260311	77714006
E	77772450	1-57/64"	1-5/8"	50200293	2-57/64"	1"	50200289	N/A	N/A
F	77261500	1-3/4"	5/8"	77261000	1-3/4"	5/8"	50400260	50400293	77269000

TYPE	TOP INSERT	BOTTOM INSERT	PIN	PINTLE	CAM
G	77464640	50400303	50400260	50400293	50400300
H	77774680	50400274	50200289	N/A	N/A

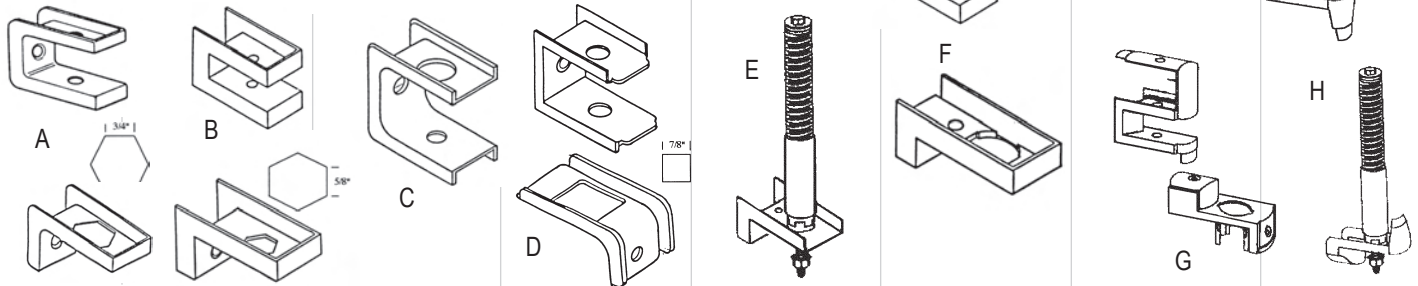

ITEM	PART #	DESCRIPTION
1	77469050	Cap
2	77469052	Female cam
3	77469054	Male cam
4	77469056	Bottom cam
1-4	77469058	Cam assembly

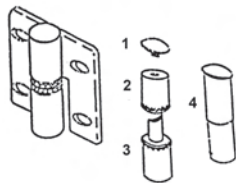

SURFACE MOUNTED HINGE REPAIR PARTS

ITEM	PART #	DESCRIPTION
1	77469002	Cap
2	77469016	Female cam housing
3	77469014	Male cam housing
4	77469012	Cam housing
5	77469008	Male pin
6	77469004	Cap (hole in center)
7	77469006	Male pin housing
8	77469010	S/S wing

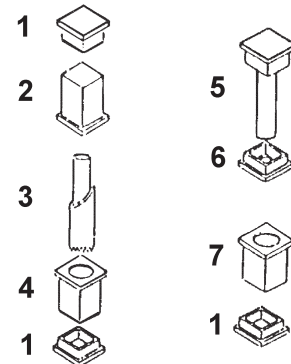
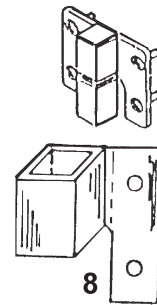

HOUSTON
800/392-5066











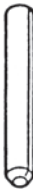









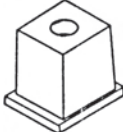

ORLANDO
800/327-3022

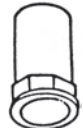
GREENVILLE
800/476-2212

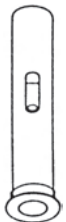
LOOK FOR US ON THE WEB AT: www.TMSSouth.com

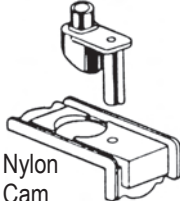
HARDWARE & TOILET PARTITIONS

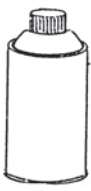
DOOR HINGE ACCESSORIES

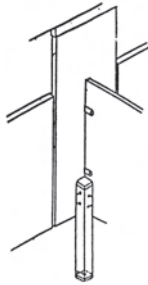
 <p>1/4" x 2-7/8" Metal 50400260 Plastic 77261516</p>	 <p>3/8" x 2-1/2" Metal 50400252 Plastic 50200289</p>	 <p>3/8" x 3" Metal 50400262</p>	 <p>3/8" x 4-1/4" Steel 77011173</p>	 <p>FITS ACCURATE # 50400255 3/8" x 2-7/8" 12/24 Internal Thread</p>	 <p>FITS AM. SANITARY, FIAT, GENERAL, & GLOBAL 3/8" x 3-5/8" # 50400259</p>
 <p>3/8" x 3" Metal 50400263</p>	 <p>3/8" x 3" Thread Metal 50400227</p>	 <p>7/32" x 3-1/4" Metal (AMPCO) 77469585</p>	 <p>5/8" Diameter 50400293</p>	 <p>1/2" Diameter 50200313</p>	 <p>Cam & Pin assembly 77005000</p>
 <p>For 11/16" Pintle 77714006</p>	 <p>For 11/16" Pintle 77460232</p>	 <p>7/8" x 1" For 3/4" Pintle 77005001</p>	 <p>Cam Top 77011807 Cam Bottom 77011806</p>	 <p>For 1/2" Pintle 50200314</p>	 <p>For 5/8" Pintle 50400069</p>
 <p>Cam Set 50200315</p>	 <p>Candle Cam for plastic laminated 77269000 (Black) 50400300 (White, uses 50400293 pintle)</p>	 <p>Candle Cam 50400301</p>	 <p>Candle Cam for metal part. 50400300</p>	 <p>Nylon Cam 77630117 Bottom Door Insert 77630114</p>	 <p>Rubber Bumper for strike & keeper Long - 77462012 Short - 77469025</p>
 <p>S/S cover plate Covers latch hole 50400009</p> <p>Conversion kit PART # 77775021</p>	 <p>Spray paint PART # 77469084</p> <p>Touch Up Paint 10 oz. Aerosol spray Almond - 77469080 Tan - 77469082</p>	 <p>Top Hinge bushing 3/8" hole - 77469060 1/4" hole - 77469062</p>	 <p>ITEM PART # DESCRIPTION 1 77775860 Toggle and screw (7777780) 2 77775861 Screw</p>	 <p>Aluminum seat leg. Used to stabilize ceiling hung partitions. PART # 50400065</p>	



**TOTAL
MAINTENANCE
SOLUTIONS**

HOUSTON
800/392-5066

ORLANDO
800/327-3022

GREENVILLE
800/476-2212

LOOK FOR US ON THE WEB AT: www.TMSSouth.com

HARDWARE & TOILET PARTITIONS

CONCEALED LATCHES

Used with latch housing

SANYMETAL

NEW STYLE
50400342 – Sold
as pair only

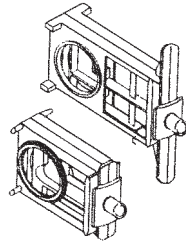
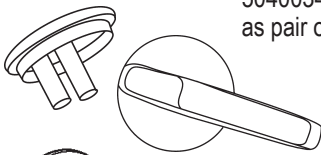

OLD STYLE
50400013 – Sold
as pair only

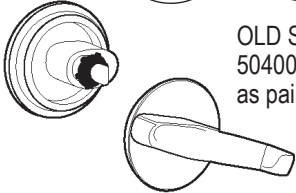

Latch Housing
- metal partitions
PART # 50200316
Latch Housing
PART # 77466626

GLOBAL - OTHERS

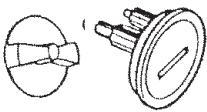

Female - 50400058
Male - 50400059

ADA LATCH SET

Male and Female - 50200294

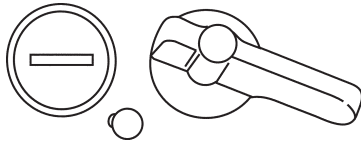

HADRIAN

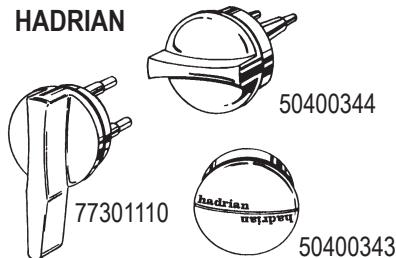

77465200

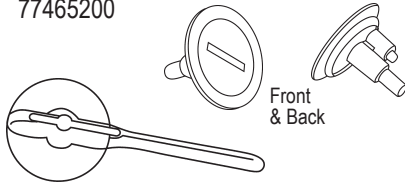

Front
& Back

ACCURATE

Male
PART #50400022

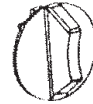

Female
PART # 77010403

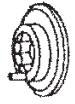

Slide pin
PART # 77010460



ADA latch



WEIS/ROBART

Door slide bolt PART # 77991043



Recessed latch
PART #
77991040

Bolt retaining clip
PART # 77991048



Latch front cover
PART # 77991044

DISCONTINUED LATCHES

Use the following:
Surface mounted latches: 50400000 or 50400001
Cover plates: 2 ea of 50400009 and
Keeper: 50400232 (IS) or 50400236 (OS)

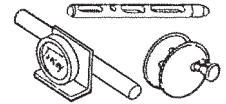

WE CAN HELP YOU WITH ALL YOUR LOCKER ROOM NEEDS!

- Locker room benches
- Shower stalls and privacy compartments
- Washroom vanities

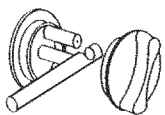
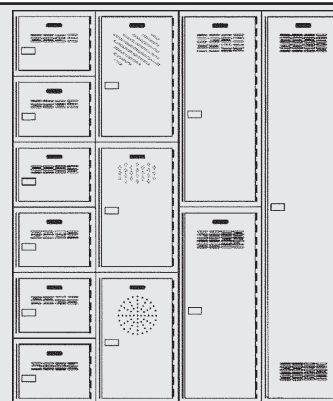

50400367

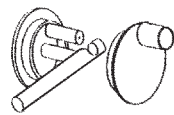

50400014

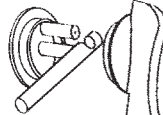

50400023

MILLS

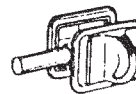

50400012

METPAR

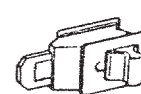

50400015

Latch, Latch Bar & Cam

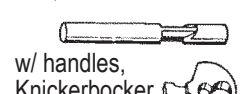

w/ handles,
Knickerbocker
77262020

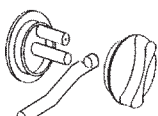

50200317

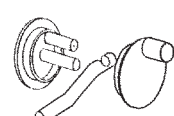

77466190

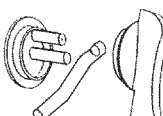

77468190

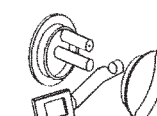

50400016



77466090

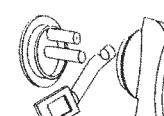

77468090



**TOTAL
MAINTENANCE
SOLUTIONS**

HOUSTON
800/392-5066

ORLANDO
800/327-3022

GREENVILLE
800/476-2212

LOOK FOR US ON THE WEB AT: www.TMSSouth.com

HARDWARE & TOILET PARTITIONS

SURFACE MOUNTED SLIDE LATCHES

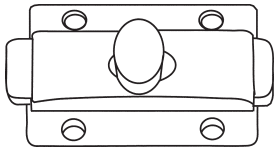

1-3/4" between screws, 4-hole
PART # 50200243

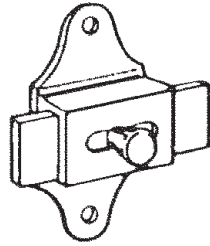

2-5/8" between screws
PART # 50400005

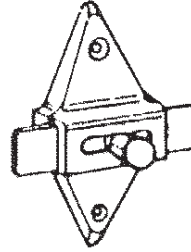

2-3/4" between screws
PART # 50400045

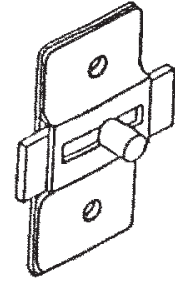

1-7/8" between screws
Stainless Steel
PART # 50400007

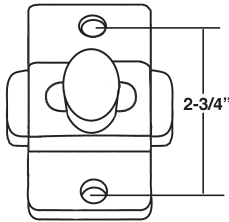

2-3/4" between screws, 2-hole
PART # 50200240 (ZAMAK)
PART # 50200242 (S/S)

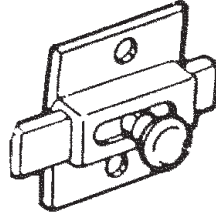

1-7/8" between screws
PART # 50400006

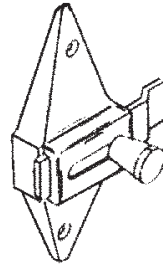

2-3/4" between screws
PART # 50400004

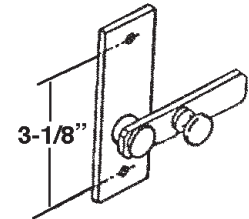

Throw Latch
50400002

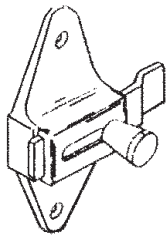

3-1/2" between screws
PART # 50400003

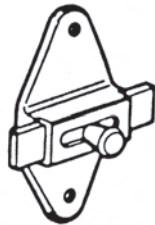

3-1/2" between screws
PART # 50400001

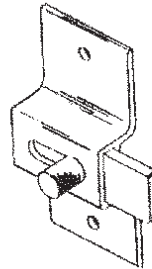

3-1/2" between screws
Aluminum
PART # 50400338

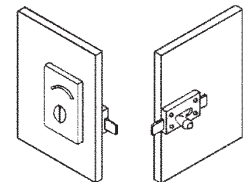

Indicator (Vacant/ Engaged)
latches are available.
Call with your requirements.

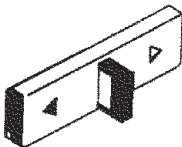

Bobrick Universal Slide Latch
RH/LH
PART # 50400064

ALL STEEL

ITEM	PART #	DESCRIPTION
1	82751000	2 - piece handle
2	82751002	1 - piece handle
3	82751004	Padlock eye
4	82751006	Box locker catch
5	82751008	Latch spring
6	82751010	Catch
7	82751012	Shoulder rivet
8	82751014	Door jamb - RH
9	82751016	Hinge
10	82751018	Hinge clip
11	82751020	Box locker catch
12	82751022	Spring for box locker catch
13	82751024	Shoulder bolt

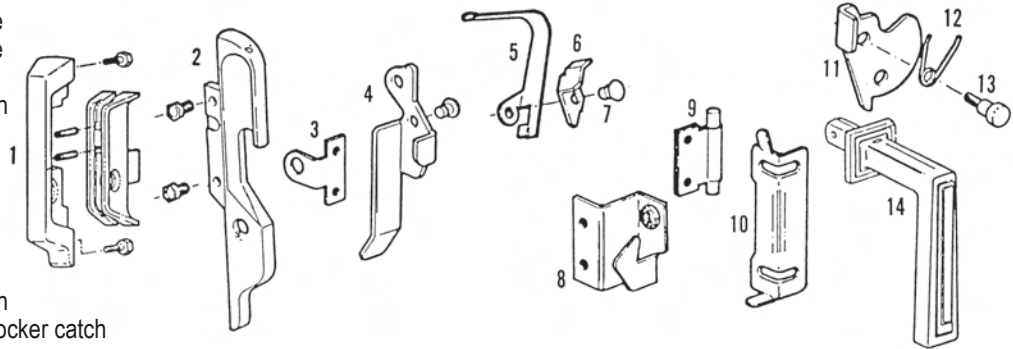

**TOTAL
MAINTENANCE
SOLUTIONS**

HOUSTON
800/392-5066

ORLANDO
800/327-3022

GREENVILLE
800/476-2212

LOOK FOR US ON THE WEB AT: www.TMSSouth.com

HARDWARE & TOILET PARTITIONS

AURORA STEEL

ITEM	PART #	DESCRIPTION
1	82751030	Lifter w/padlock loop
2	82751032	Bumper for lifter
3	82751034	Lifter spring
4	82751036	Lifter pin
5	82751038	Face plate
6	82751040	Lifter cover
7	82751042	Grip type handle
8	82751044	Hinge
9	82751046	Door jamb
10	82751048	Bumper for door jamb
11	82751050	Latch for locking bar
12	82751052	Latch pin
13	82751054	Coil spring for locking bar
14	82751056	Number plate for handle
15	82751051	Number plate for door

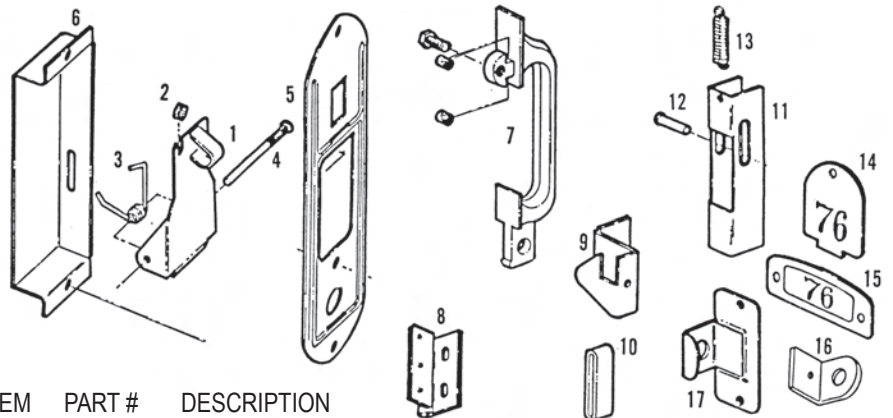

ITEM	PART #	DESCRIPTION
16	82751055	Box locker padlock loop
17	82751057	Box locker door pull

INTERIOR

ITEM	PART #	DESCRIPTION
1	82751060	Locker handle
2	82751062	Screw 8-32 x 3/8" ST
3	82751064	Locker handle
4	82751066	Locker handle
5	82751068	Screw 8-32 x 5/16"
6	82751070	Locker handle
7	82751072	Latch finger
8	82751074	Spring
9	82751076	Lift
10	82751078	Lift
11	82751080	Upper locking bar assembly
12	82751082	Interior latch - top & bottom
13	82751084	Door jamb - RH
	82751086	Door jamb - LH
14	82751088	Door jamb - RH
	82751090	Door jamb - LH
15	82751092	Spring
16	82751094	Latch bar bumper
17	82751096	Box locker latch
18	82751098	Stud
19	82752000	Spring
20	82752002	Coiled spring
21	82752004	Hinge
22	82752006	Nut
23	82752008	Expanded metal lock handle
24	82752010	Keeper
25	87572012	Box locker friction catch
26	82752014	Box locker pull
27	82752016	Latch assembly
28	82752018	Nylon latch finger
	82752020	Metal latch finger
29	82752024	Padlock clip & lock catch - RH
	82752026	Padlock clip & lock catch - LH
30	82752028	Wrench
31	82752030	Nylon retainer clip
32	82752032	Recess lift
33	82752034	Recess handle

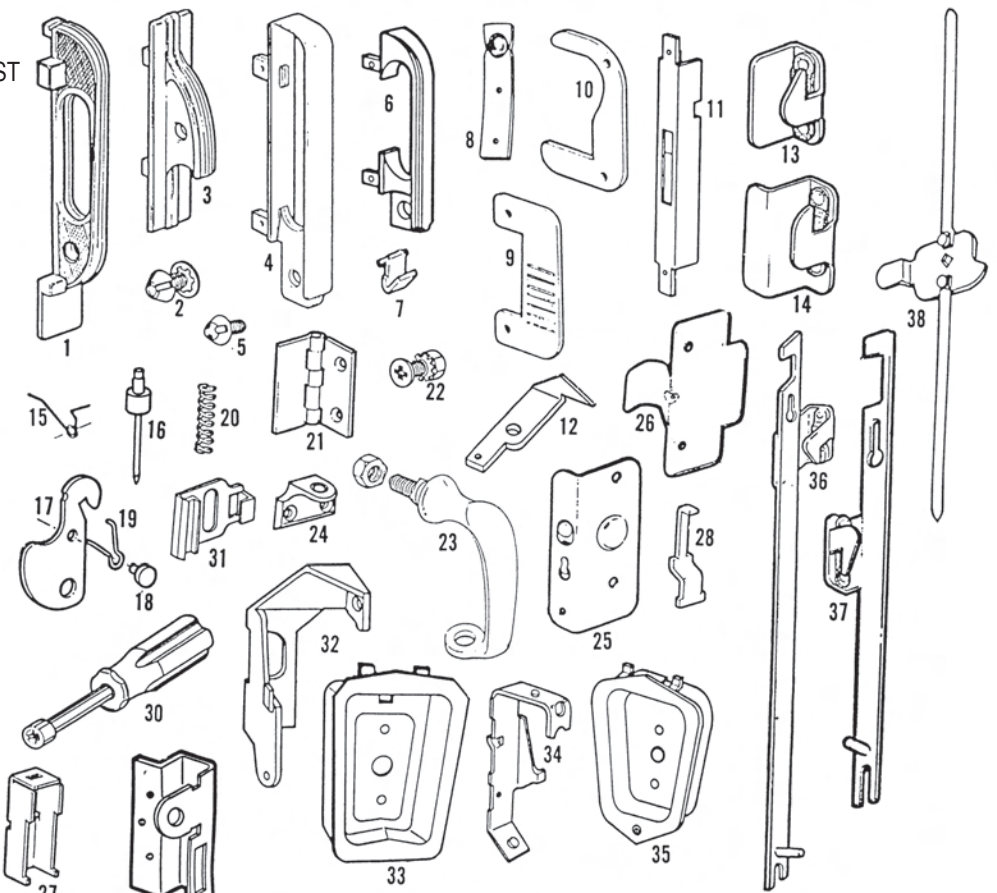

34	82752036	Recess lift
35	82752038	Recess handle
36	82757000	Latch for 2 - person locker - LH
37	82757002	Latch for 2 - person locker - RH
38	82757004	Lock bar for single tier - 60"
	82757006	Lock bar for single tier - 72"
	82757008	Lock bar for double tier - 30"
	82757010	Lock bar for double tier - 36"



**TOTAL
MAINTENANCE
SOLUTIONS**

HOUSTON
800/392-5066

ORLANDO
800/327-3022

GREENVILLE
800/476-2212

LOOK FOR US ON THE WEB AT: www.TMSSouth.com

HARDWARE & TOILET PARTITIONS

LYON

ITEM	PART #	DESCRIPTION
1	82752040	Door jamb
2	82752042	Door jamb - RH
	82752044	Door jamb - LH
3	82752046	Door jamb - RH
	82752048	Door jamb - LH
4	82752050	Door jamb
5	82752052	Door jamb - RH
	82752054	Door jamb - LH
6	82752056	Door jamb
7	82752058	Door jamb
8	82752060	Door jamb
9	82752062	Door jamb
10	82752064	Door jamb - RH
	82752066	Door jamb - LH
11	82752068	Door jamb
12	82752070	Door jamb
13	82752072	Gravity latch
14		Number plate
15	82752076	Box locker pull
16	82752078	Hinge
17	82752079	Hinge (used 1935-1953)
18	82752080	Roll point catch
19	82752082	Spring for S.A. latch
20	82752084	Spring actuated latch
21	82752086	Padlock attachment - RH
	82752088	Padlock attachment - LH
22	82752089	Wire basket padlock attachment
23	82757072	Pull-through bumper - current door jambs
24	82757074	Bumper w/pop rivet O/S door jambs
25	82757076	Old style lock bar lift finger
26	82757078	Door closer spring
27	82757080	Angle bracket - O/S angle frame locker
28	82757082	Top door jamb - Dble. door locker
29	82757084	Bottom door jamb - Dble. door locker
30	82757086	Lock wire strap - 2 person locker - RH
	82757088	Lock wire strap - 2 person locker - LH
31	82757090	Upper rod guide - expanded metal locker
32	82753026	Wire latch bar - 2 person locker - RH - short
33	82753028	Wire latch bar - 2 person locker - LH - long
34	82757052	O/S latch bar - 2 person locker - LH (17-17/32")
	82757054	O/S latch bar - 2 person locker - LH (18-1/32")
35	82757056	O/S latch bar - 2 person locket - short (19-3/32")
	82757058	O/S latch bar - 2 person locket - short (19-19/32")
36	82757060	Locking bar spring w/rivet - long RH
	82757062	Locking bar spring w/rivet - long LH
37	82757064	Lock rod & cam assy. - single tier 60"
	82757066	Lock rod & cam assy. - single tier 72"
	82757068	Lock rod & cam assy. - Dble. tier 30"
	82757070	Lock rod & cam assy. - Dble. tier 36"
38	82752092	Handle lift - RH
	82752094	Handle lift - LH
39	82752090	Handle housing
40	82752098	Handle lift - RH
	82753000	Handle lift - LH
41	82752096	Handle housing
42	82753004	Handle lift - RH
	82753006	Handle lift - LH
43	82753002	Handle housing
44	82753008	Rolled edge handle guide
45	82753010	Rolled edge handle lift
46	82753012	Flat strap handle guide
47	82753014	Flat strap handle lift

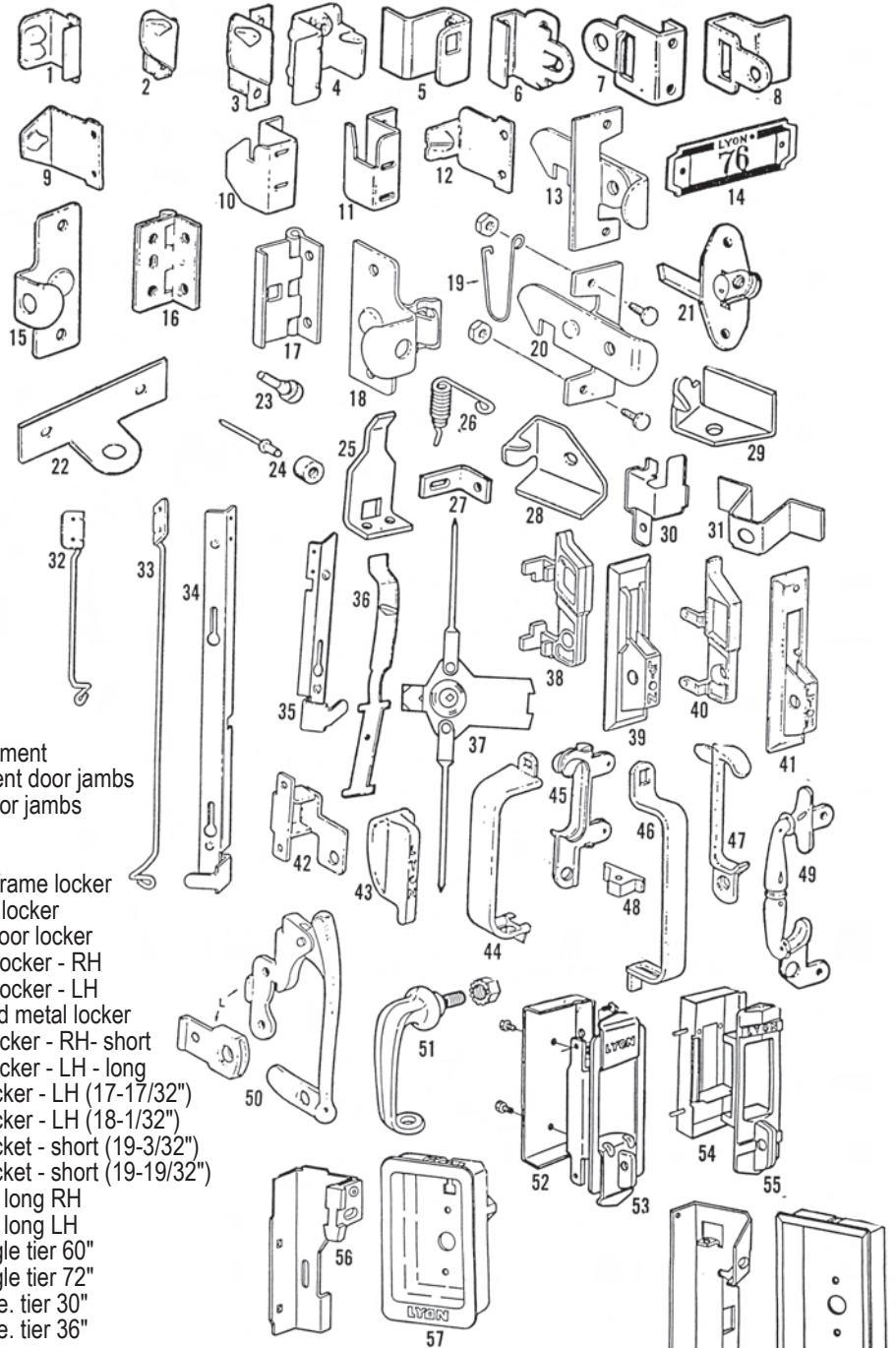

48	82757050	Bumper for rolled edge handle guide
49	82753024	Durand No. 6 handle
50	82753020	3 - piece cast brass handle
51	82753022	Expanded metal locker handle
52	82753018	Cover plate for SM handle
53	82753016	Sheetmetal handle
56	82753030	Recess lift
57	82753032	Recess handle
58	82753034	Recess lift
59	82753036	Recess handle



**TOTAL
MAINTENANCE
SOLUTIONS**

HOUSTON
800/392-5066

ORLANDO
800/327-3022

GREENVILLE
800/476-2212

LOOK FOR US ON THE WEB AT: www.TMSSouth.com

HARDWARE & TOILET PARTITIONS

MEDART

ITEM	PART #	DESCRIPTION
1	82753040	Locker handle assy. - RH
	82753042	Locker handle assy. - LH
2	82753044	Locker handle assy. RH
	82753045	Locker handle assy. LH
3	82753046	Locker handle
4	82753048	Door stop RH (1958-1961)
	82753049	Door stop LH (1958-1961)
5	82753050	Door stop RH (1961-current)
	82753051	Door stop LH (1961-current)
6	82753052	Door stop RH (1954-1958)
	82753053	Door stop LH (1954-1958)
7	82753054	Door stop RH (1945-1954)
	82753055	Door stop LH (1945-1954)
8	82753072	Door stop bumper - small
9	82753074	Door stop bumper - large
10	82753084	Standard 2-piece kick proof handle
11	82753086	Modified 2-piece kick proof handle
12	82753066	Locker handle
13	82753068	Locker handle
14	82753088	Padlock hasp for item 3
15	82753089	Padlock hasp for item 12 & 13 - RH
	82753090	Padlock hasp for item 12 & 13 - LH
16	82753076	Lockrod lift
17	82753078	Box locker catch - old style
18	82753080	Box locker catch - new style
19	82753082	Finger pull for item 18
20	82754012	Basket rack padlock attachment
21	82754000	Turn type handle
	82753099	Cup washer for handle
	82754001	Bolt for handle
22	82753096	Short flat cam lever
23	82753098	Long flat cam lever
24	82753058	Lockrod spring - old style
25	82753062	Lockrod spring - new style
26	82753061	Roller for lockrod spring
27	82753060	Hollow rivet for lockrod spring
28	82753056	Solid rivet for lockrod spring
29	82754014	Lockrod latch catch assembly
30	82754008	Hinge
31	82754002	Continuous hinge for 2 person locker
32	82754004	Lockrod for upper 2 person locker
33	82754003	Lockrod for 72" single tier
	82754005	Lockrod for 60" single tier
	82754006	Lockrod for 36" double tier
	82754007	Lockrod for 30" double tier
34	82754016	Recess lift - since 1987
35	82754018	Recess handle - since 1987

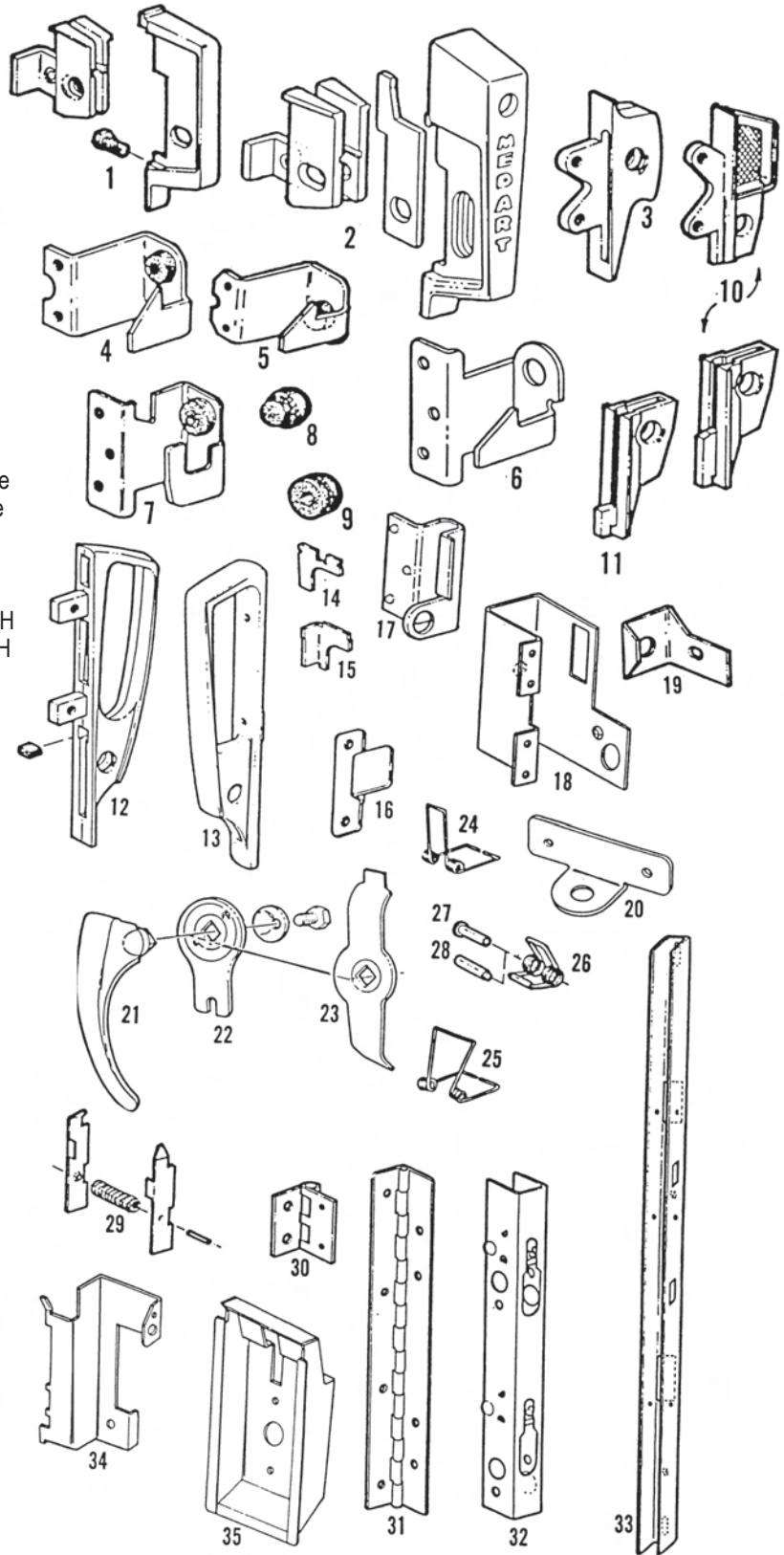

**TOTAL
MAINTENANCE
SOLUTIONS**

HOUSTON
800/392-5066

ORLANDO
800/327-3022

GREENVILLE
800/476-2212

LOOK FOR US ON THE WEB AT: www.TMSSouth.com

HARDWARE & TOILET PARTITIONS

PENCO

ITEM	PART #	DESCRIPTION
1	82754030	Vanguard 2 – piece handle (used after 1967)
2	82754032	Bumper for Vanguard handle
3	82754034	Finger lift handle 1 – piece (1958-1967)
4	82754036	Padlock staple for finger lift handle
5	82754037	Old style palnut (small) for Vanguard handle (prior to 1972)
6	82754038	New style palnut (med. size) for Vanguard handle (after 1972)
7	82754039	Palnut for finger lift handle
8	82754040	Penn Metal die cast handle (prior to 1958)
9	82754042	Penn Metal padlock hasp (Die cast handle)
10	82754044	Penn Metal cast brass handle
11	82754046	Door jamb – RH
	82754047	Door jamb – LH
12	82754048	Bumper for door jamb
13	82754050	Box locker door pull
14	82754052	Hinge
15	82754054	Box locker padlock
16	82754056	Basket rack padlock attachment
17	82754058	Replacement clip – 2 person locker (guide for latch bar)
18	82754059	Cam for double door locker – upper
	82754060	Cam for double door locker – lower
19	82754061	Spring for double door locker – upper
	82754062	Spring for double door locker – lower
20	82754063	Shoulder rivet for double door locker
21	82754064	Palnut tool – old style (used prior to 1972)
22	82754066	Palnut tool – new style (used after 1972)
23	82754067	Coiled spring for nylon latch clip
24	82754068	Nylon latch clip for lock bar
25	82754070	Lock bar for upper 2 person locker - RH
	82754071	Lock bar for upper 2 person locker - LH
26	82754072	Latch bar for 2 person locker - short
27	82754074	Latch bar for 2 person locker - long
28	82754076	Coiled spring for steel latch clip
29	82754078	Steel latch clip for lock bar (1958-1967)
30	82754080	Spiral pin for lock bar (used after 1967)
31	82754082	Lift for recessed cup - RH (before 1988)
	82754084	Lift for recessed cup - LH (before 1988)
32	82754086	Recessed handle cup (before 1988)
33	82754088	Lift for recessed cup - RH (1988 to present)
	82754090	Lift for recessed cup - LH (1988 to present)
34	82754092	Recessed handle cup (1988 to present)

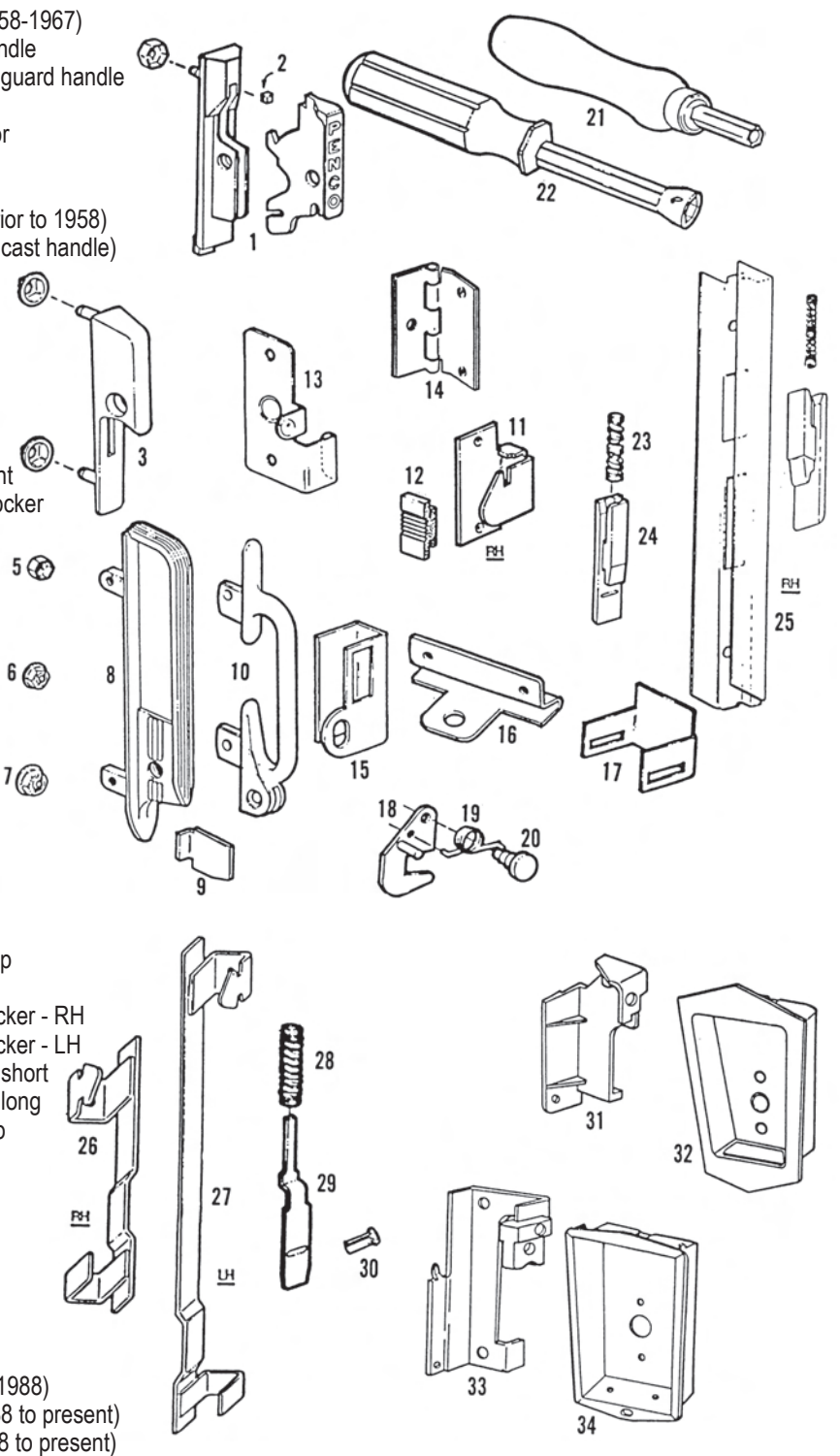

HARDWARE & TOILET PARTITIONS

REPUBLIC STEEL

ITEM	PART #	DESCRIPTION
1	82755030	Low decibel locker handle assy. - RH
	82755031	Low decibel locker handle assy. - LH
2	82755032	No. 10 locker handle (used 1960 to 1962)
3	82755034	No. 9 locker handle (used 1959 to 1960)
4	82755036	No. 8 locker handle (used 1936 to 1959)
5	82755038	No. 6 locker handle (used 1934 to 1936)
6	82755040	No. 12 locker handle assy. - RH (used 1965 - current)
	82755041	No. 12 locker handle assy. - LH (used 1965 - current)
	82755042	Lift only - RH
	82755043	Lift only - LH
	82755044	Case only
7	82755046	No. 11 locker handle assy. - RH (used 1962 - 1965)
	82755047	No. 11 locker handle assy. - LH (used 1962 - 1965)
	82755048	Lift only - RH
	82755049	Lift only - LH
	82755050	Case only
8	82755052	Expanded metal locker handle
9	82755054	Old style handle for swinging shelving doors
10	82755056	Recessed handle slide plate - RH
	82755057	Recessed handle slide plate - LH
11	82755058	Recessed handle case
12	82755059	Black plastic handle w/rievet
13	82755060	Padlock stop for No. 8, 9 & 10 handle
14	82755062	Door jamb
15	82755063	Old style door jamb - RH
	82755064	Old style door jamb - LH
16	82755065	Door jamb for 2 person locker latch bar
17	82755066	Box locker friction catch
18	82755068	Box locker escutcheon plate
19	82755070	Box locker door jamb - RH
20	82755072	Hinge
21	82755074	Spring latch for lock bar
22	82755076	Lock bar latch finger spring
23	82755078	Lock bar latch finger
24	82755080	Tube rivet for lock bar
25	82755082	Current lock bar for upper 2 person locker door
26	82755084	Old style lock bar for upper 2 person locker door - RH
	82755085	Old style lock bar for upper 2 person locker door - LH
27	82755086	Plastic guide for O/S low dec./mondrain lock bar
28	82755088	1 - point latch spring
29	82755090	1 - point latch washer
30	82755091	1 - point latch handle
31	82755092	1 - point latch stud
32	82755093	1 - point latch bumper
33	82755094	1 - point latch attachment bracket
34	82755096	Stud for double door locker cam
35	82755098	Top spring for double door locker cam
36	82756000	Top cam for double door locker
37	82756002	Bottom spring for double door locker cam
38	82756004	Bottom cam for double door locker
39	82756006	Frame bumper for double door locker
40	82756008	Padlock clip for basket rack
41	82756010	Current number plate
42	82756012	Old style number plate
43	82756014	Coat rod bracket for single prong wall
44	82756016	Single prong wall hook - RH
	82756020	Single prong wall hook - LH
45	82756022	Double prong wall hook
46	82756024	Round head shoulder rivet O/S latch bar
47	82756026	Latch bar for 2 person locker - short

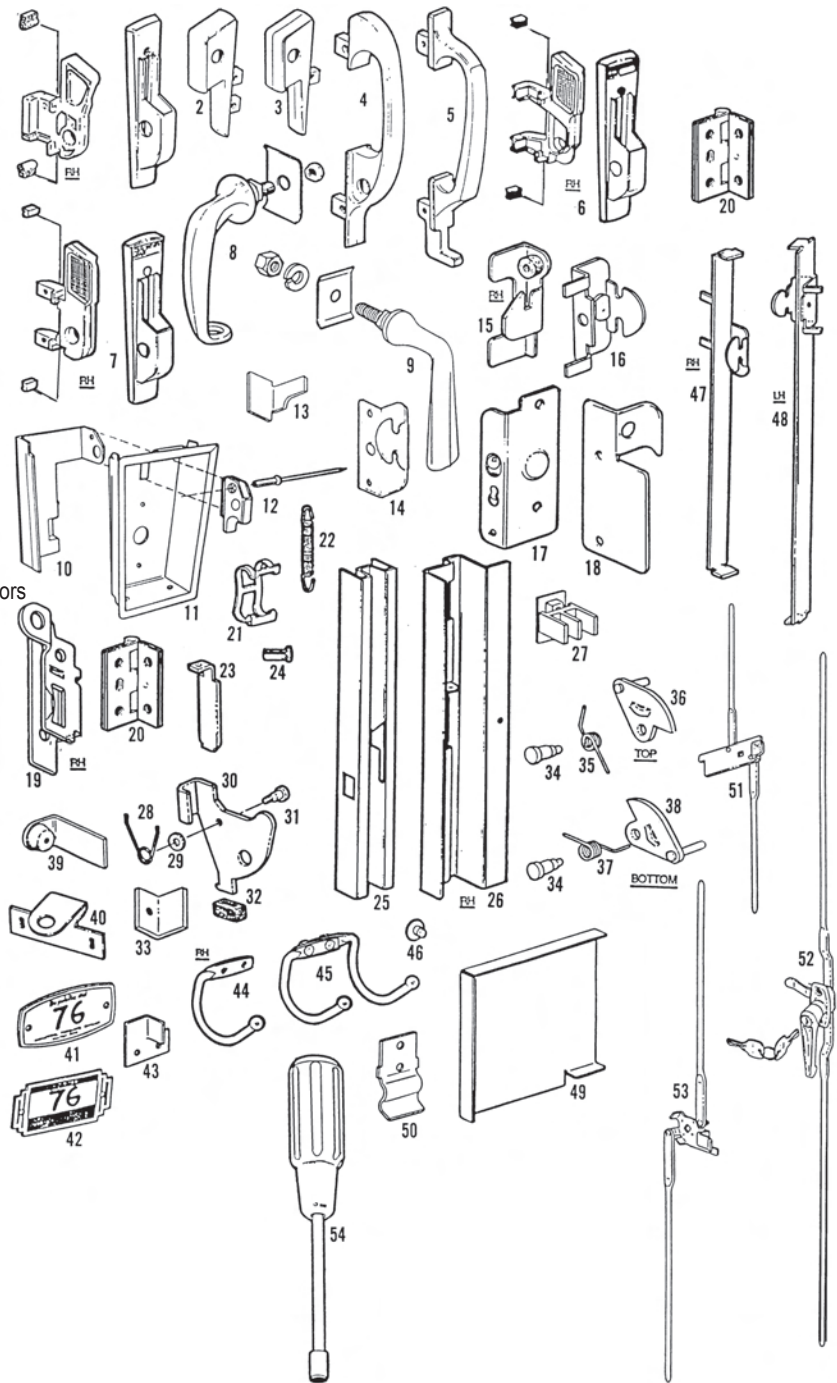

ITEM	PART #	DESCRIPTION
48	82756028	Latch bar for 2 person locker - long
49	82756030	Corner recess trim cap (3" SQ.) - unpainted
50	82756032	Trim clip for recessed trim
51	82756034	Expanded metal lock bar assy. 72" single tier
	82756035	Expanded metal lock bar assy. 60" single tier
	82756036	Expanded metal lock bar assy. 36" double tier
	82756037	Expanded metal lock bar assy. 30" double tier
52	82756038	Lock bar & handle assy. O/S storage cabinet
53	82756040	Cam & lock bar assy. O/S swinging shelving doors (rods to be cut to proper length)
54	82756042	Gulmite wrench



**TOTAL
MAINTENANCE
SOLUTIONS**

HOUSTON
800/392-5066

ORLANDO
800/327-3022

GREENVILLE
800/476-2212

LOOK FOR US ON THE WEB AT: www.TMSSouth.com

HARDWARE & TOILET PARTITIONS

WORLEY

ITEM	PART #	DESCRIPTION
1	82756050	Automatic locker handle
2	82756052	Handle case only
3	82756054	Handle slide only
4	82756056	1 - piece handle
5	82756058	Handle - bumper box assembly
6	82756060	Roll pin for handle
7	82756062	Automatic jamb assembly
8	82756064	Housing for jamb
9	82756066	Handle for gravity latch
10	82756068	Clip for jamb
11	82756070	Plunger for jamb - steel
	82756072	Plunger for jamb - plastic
12	82756074	Coil spring for jamb
13	82756076	Jamb for gravity latch
14	82756078	Door stop for gravity latch
15	82756080	Hinge
16	82756082	Clip for locking channel
17	82756084	Number plate

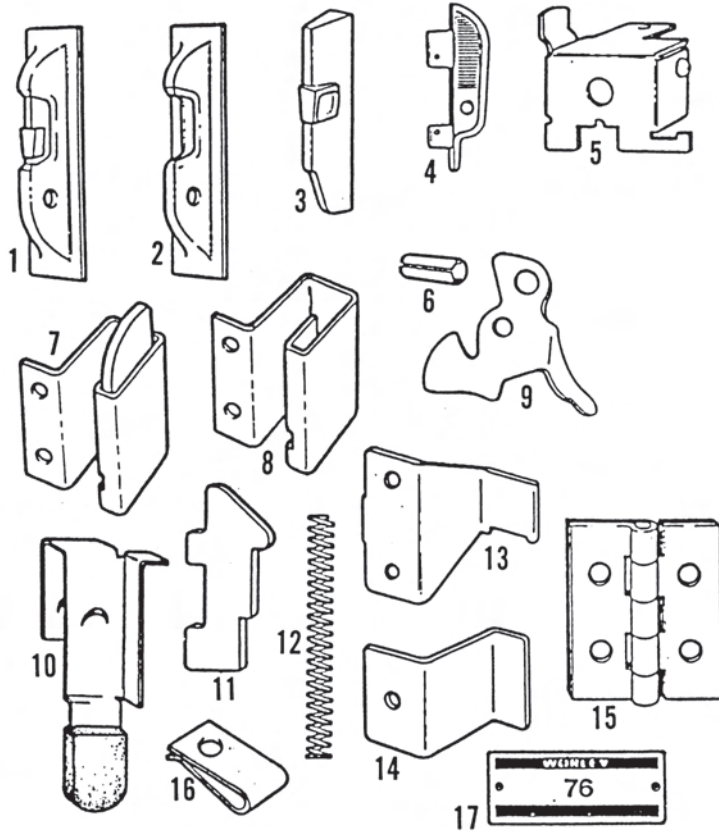

SPECIALTY GRAB BARS

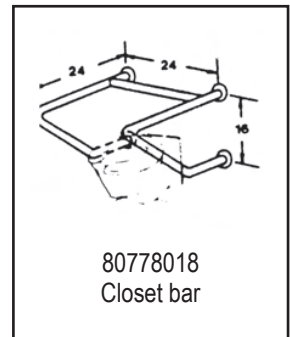
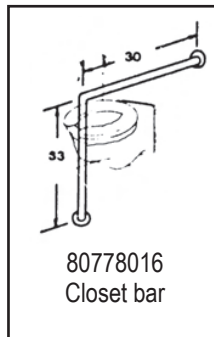
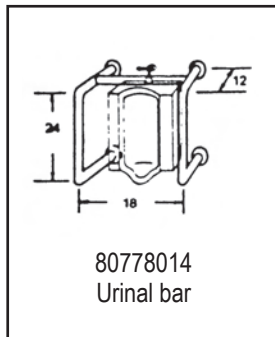
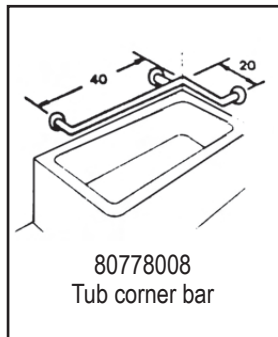
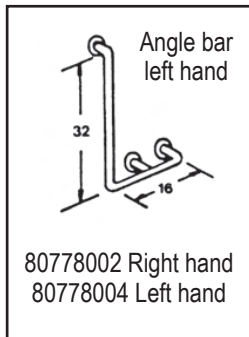

STAINLESS STEEL GRAB BARS WITH SANIGUARD®

- 24" Stainless Steel Grab Bar, 1-1/2" OD
Part # 50250003
- 32" Stainless Steel Grab Bar, 1-1/2" OD
Part # 50250005
- 36" Stainless Steel Grab Bar, 1-1/2" OD
Part # 50250006



NEED A QUOTE ON LOCKERS?
Give us a call for all types of lockers (metal, phenolic, plastic)



TOTAL MAINTENANCE SOLUTIONS

HOUSTON
800/392-5066

ORLANDO
800/327-3022

GREENVILLE
800/476-2212

LOOK FOR US ON THE WEB AT: www.TMSSouth.com

HARDWARE & TOILET PARTITIONS

60 SERIES CHANNEL BALANCES

1/2" channel balance
(actually 5/8" but considered
1/2" in the trade)

ORDERING INFORMATION

1. Measure metal channel balance length (do not include plastic ends).
2. Check number stamped on channel: e.g., 2010, 28A, 3620, etc.
3. Select our corresponding part number from the chart
4. Balances stamped with a 3-digit number (e.g., 122, 183, 143) or a 2-digit number (e.g., 15, 18, 19 will require you to contact your sales representative for more information, such as exact channel length, type of ends attached, etc.

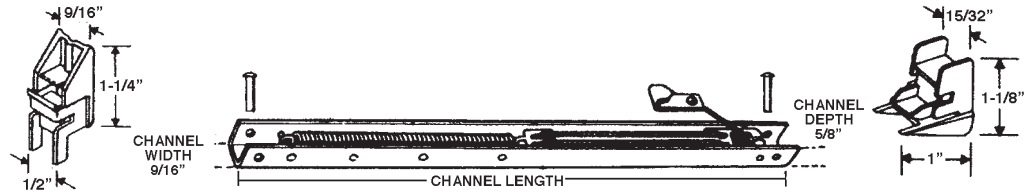

POPULAR COMBINATIONS

PART # 50605070 TOP

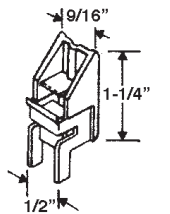

PART # 50605010 BOTTOM

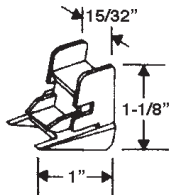

PART # 50605070 TOP

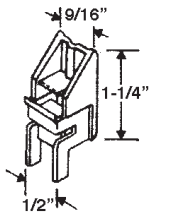

PART # 50605020 BOTTOM

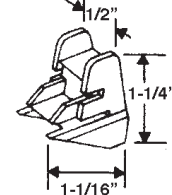

PART # 50605640 TOP

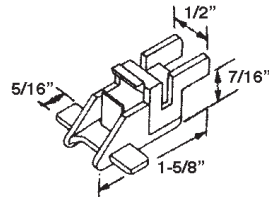

PART # 50605655 BOTTOM

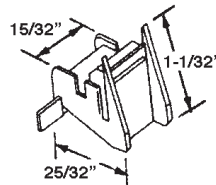

PART # 50605910 TOP

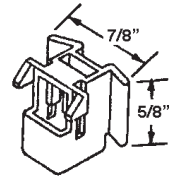

PART # 50605900 BOTTOM

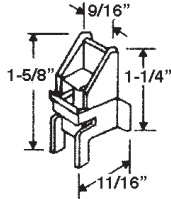

PART # 50605080 TOP

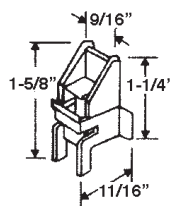

PART # 50605030 BOTTOM

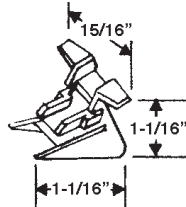

PART # 50605950 TOP

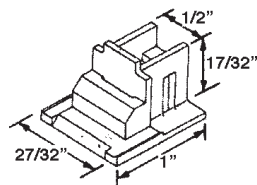

PART # 50605960 BOTTOM

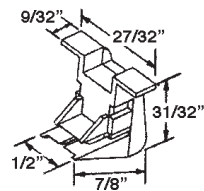

PART # 50605950 TOP

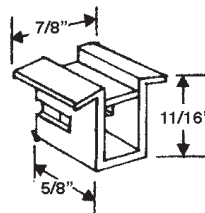

PART # 50605960 BOTTOM

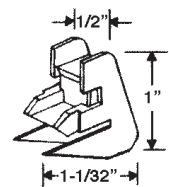

PART # 50605950 TOP

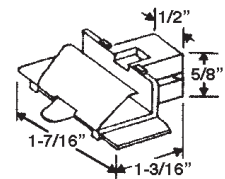

PART # 50605960 BOTTOM

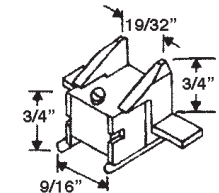

HOUSTON
800/392-5066

ORLANDO
800/327-3022

GREENVILLE
800/476-2212

LOOK FOR US ON THE WEB AT: www.TMSSouth.com

HARDWARE & TOILET PARTITIONS

60 SERIES 1/2" WINDOW BALANCE CHART

**TO ORDER A 24" WINDOW BALANCE STAMPED 2330
SPECIFY
TMS # (50602330)
BALANCE TOP END TMS # (50605070)
BALANCE BOTTOM END TMS # (50605010)**



1/2" wide

SEE ENDS ON PAGE 5-21

LENGTH	TMS PART #	NUMBER STAMPED ON BALANCE	TMS PART #	NUMBER STAMPED ON BALANCE	TMS PART #	NUMBER STAMPED ON BALANCE	TMS PART #	NUMBER STAMPED ON BALANCE	TMS PART #	NUMBER STAMPED ON BALANCE
13"	50601210	1210	50601220	1220	50601230	1230	50601240	1240	—	—
14"	50601310	1310	50601320	1320	50601330	1330	50601340	1340	—	—
15"	50601410	1410	50601420	1420	50601430	1430	50601440	1440	—	—
16"	50601510	1510	50601520	1520	50601530	1530	50601540	1540	—	—
17"	50601610	1610	50601620	1620	50601630	1630	50601640	1640	—	—
18"	50601710	1710	50601720	1720	50601730	1730	50601740	1740	—	—
19"	50601810	1810	50601820	1820	50601830	1830	50601840	1840	—	—
20"	50601910	1910	50601920	1920	50601930	1820	50601940	1940	—	—
21"	50602010	2010	50602020	2020	50602030	2030	50602040	2040	—	—
22"	50602110	2110	50602120	2120	50602130	2130	50602140	2140	—	—
23"	50602210	2210	50602220	2220	50602230	2230	50602240	2240	—	—
24"	50602310	2310	50602320	2320	50602330	2330	50602340	2340	—	—
25"	50602410	2410	50602420	2420	50602430	2430	50602440	2440	—	—
26"	50602510	2510	50602520	2520	50602530	2530	50602540	2540	—	—
27"	50602610	2610	50602620	2620	50602630	2630	50602640	2640	—	—
28"	50602710	2710	50602720	2720	50602730	2730	50602740	2740	—	—
29"	50602810	2810	50602820	2820	50602830	2830	50602840	2840	50602850	2850
30"	50602910	2910	50602920	2920	50602930	2930	50602940	2940	50602950	2950
31"	50603010	3010	50603020	3020	50603030	3030	50603040	3040	50603050	3050
32"	50603110	3110	50603120	3120	50603130	3130	50603140	3140	50603150	3150
33"	50603210	3210	50603220	3220	50603230	3230	50603240	3240	50603250	3250
34"	50603310	3310	50603320	3320	50603330	3330	50603340	3340	50603350	3350
35"	50603410	3410	50603420	3420	50603430	3430	50603440	3440	50603450	3450
36"	50603510	3510	50603520	3520	50603530	3530	50603540	3540	50603550	3550



**TOTAL
MAINTENANCE
SOLUTIONS**

HOUSTON
800/392-5066

ORLANDO
800/327-3022

GREENVILLE
800/476-2212

LOOK FOR US ON THE WEB AT: www.TMSSouth.com

HARDWARE & TOILET PARTITIONS

64 SERIES 3/8" CHANNEL BALANCES

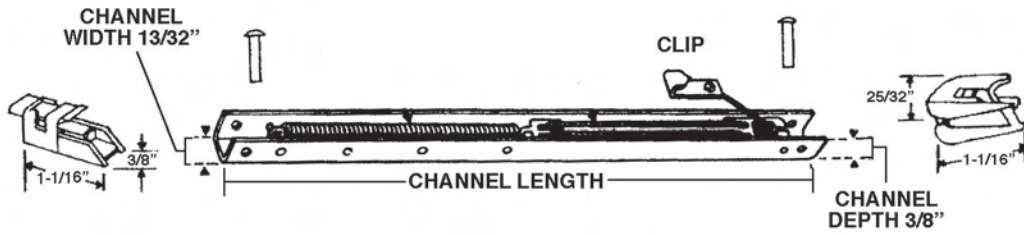

ORDERING INFORMATION

1. Measure metal channel balance length (do not include plastic ends).
2. Check number stamped on channel: eg., 19A, 22B, 28C, etc.
3. Select our corresponding part number from the chart (next page).
4. To identify the top and bottom ends to be attached see illustrations below..

TOP BRACKET
PART # 50645000

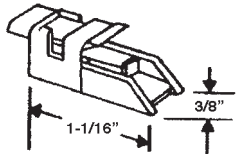

TOP BRACKET
PART # 50645010

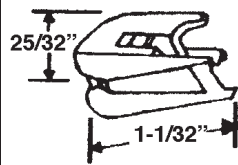

SASH GUIDE
PART # 50646000

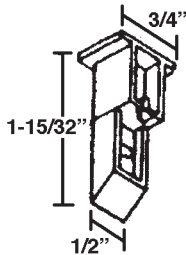

BOTTOM BRACKET
PART # 50646010

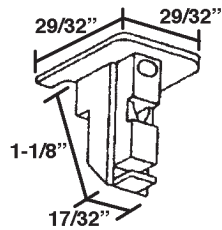

BOTTOM BRACKET
PART # 50645020

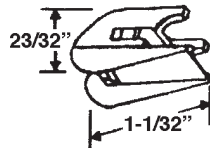

BOTTOM BRACKET
PART # 50645030

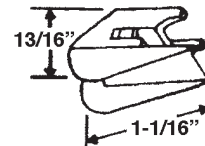

BOTTOM BRACKET
PART # 50645050

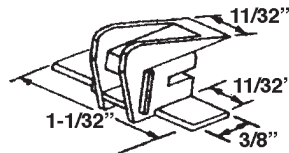

BOTTOM BRACKET
PART # 50645060

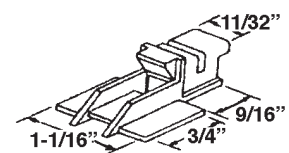

HARDWARE & TOILET PARTITIONS**64 SERIES 3/8" WINDOW BALANCES**

**TO ORDER A 24" WINDOW BALANCE STAMPED 23C
SPECIFY
TMS # (50642330)
BALANCE TOP END TMS # (50645020)
BALANCE BOTTOM END TMS # (50645030)**

LENGTH	TMS #	NUMBER STAMPED ON BALANCE	TMS #	NUMBER STAMPED ON BALANCE	TMS #	NUMBER STAMPED ON BALANCE
10"	50640910	9A	50649200	9B	506409300	9C
11"	50641010	10A	50641020	10B	50641030	10C
12"	50641110	11A	50641120	11B	50641130	11C
13"	50641210	12A	50641220	12B	50641230	12C
14"	50641310	13A	50641320	13B	50641330	13C
15"	50641410	14A	50641420	14B	50641430	14C
16"	50641510	15A	50641520	15B	50641530	15C
17"	50641610	16A	50641620	16B	50641630	16C
18"	50641710	17A	50641720	17B	50641730	17C
19"	50641810	18A	50641820	18B	50641830	18C
20"	50641910	19A	50641920	19B	50641930	19C
21"	50642010	20A	50642020	20B	50642030	20C
22"	50642110	21A	50642120	21B	50642130	21C
23"	50642210	22A	50642220	22B	50642230	22C
24"	50642310	23A	50642320	23B	50642330	23C
25"	50642410	24A	50642420	24B	50642430	24C
26"	50642510	25A	50642520	25B	50642530	25C
27"	50642610	26A	50642620	26B	50642630	26C
28"	50642710	27A	50642720	27B	50642730	27C
29"	50642810	28A	50642820	28B	50642830	28C
30"	50642910	29A	50642920	29B	50642930	29C
31"	50643010	30A	50643020	30B	50643030	30C
32"	50643110	31A	50643120	31B	50643130	31C
33"	50643210	32A	50643220	32B	50643230	32C

SEE ENDS ON
PAGE 5-23



**TOTAL
MAINTENANCE
SOLUTIONS**

HOUSTON
800/392-5066

ORLANDO
800/327-3022

GREENVILLE
800/476-2212

LOOK FOR US ON THE WEB AT: www.TMSSouth.com

HARDWARE & TOILET PARTITIONS

70 SERIES 5/8" TUBE BALANCE AND ACCESSORIES

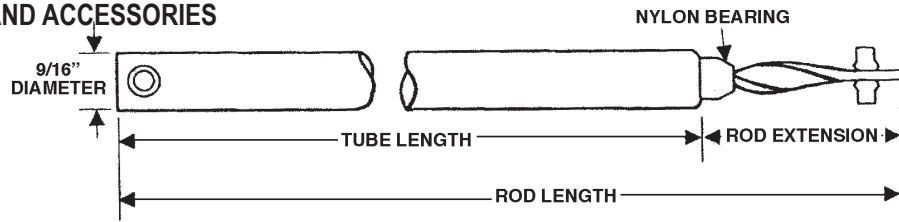

ORDERING INFORMATION

1. Measure metal tube length. (Do not include nylon bearing).
2. Measure spiral rod length. (Make sure rod is flush with screw hole at end of tube before measuring)
3. Identify the color of the bearing (e.g., black, red or blue) and select our part # from the chart below.
4. Identify the appropriate metal bracket or other related accessories on chart provided below.

	ROD LENGTH	WHITE BEARING	RED BEARING	BLUE BEARING
TUBE LENGTH	A	B	C	D
10"	10-9/16"	50720130	—	—
11"	11-9/16"	50720131	—	—
12"	12-9/16"	50720132	—	—
13"	13-9/16"	50720133	50720134	—
14"	14-9/16"	50720135	50720136	50720137
15"	15-9/16"	50720138	50720139	50720140
16"	16-9/16"	50720141	50720142	50720143
17"	17-9/16"	50720144	50720145	50720146
18"	18-9/16"	50720147	50720148	50720149
19"	19-9/16"	50720150	50720151	50720152
20"	20-9/16"	50720153	50720154	50720155
21"	21-9/16"	50720156	50720157	50720158
22"	22-9/16"	50720159	50720160	50720161
23"	23-9/16"	50720162	50720163	50720164
24"	24-9/16"	50720165	50720166	50720167
25"	25-9/16"	50720168	50720169	50720170
26"	26-9/16"	50720171	50720172	
27"	27-9/16"	50720173	50720174	
28"	28-9/16"	50720175	50720176	
29"	29-9/16"	50720177	50720178	
30"	30-9/16"	50720179	50720180	
31"	31-9/16"	50720181	50720182	
32"	32-9/16"	50720183	50720184	
33"	33-9/16"	50720185		
34"	34-9/16"	50720186		
35"	35-9/16"	50720187		
36"	36-9/16"	50720188		
37"	37-9/16"	50720189		

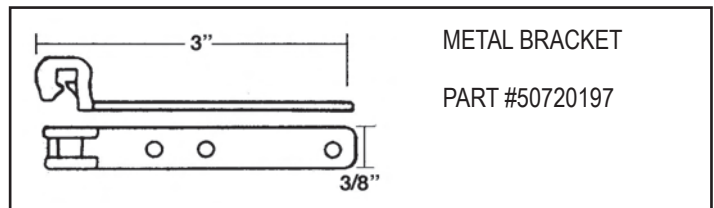
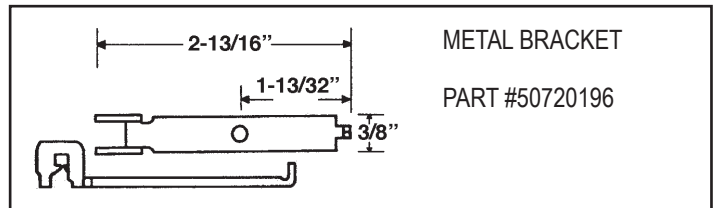
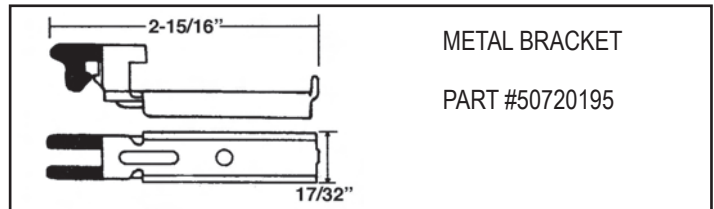
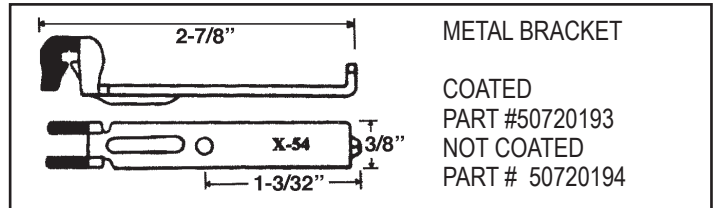
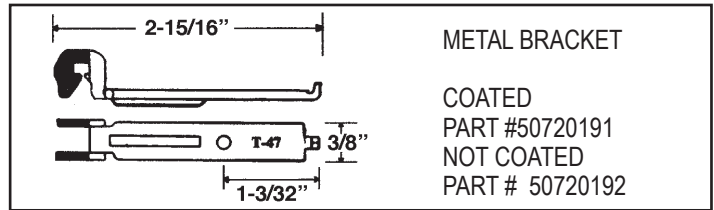
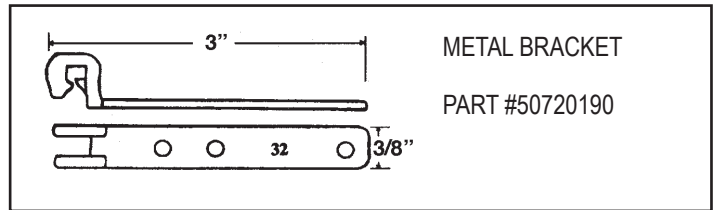

**TOTAL
MAINTENANCE
SOLUTIONS**

HOUSTON
800/392-5066

ORLANDO
800/327-3022

GREENVILLE
800/476-2212

LOOK FOR US ON THE WEB AT: www.TMSSouth.com

HARDWARE & TOILET PARTITIONS

72 SERIES 5/8" TUBE BALANCE AND ACCESSORIES

(Tube diameter 9/16" but considered 5/8" in the trade)

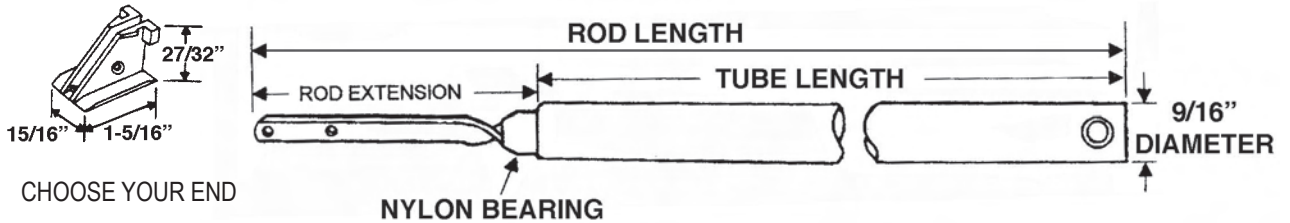

CHOOSE YOUR END

ORDERING INFORMATION

1. Measure metal tube length. (Do not include nylon bearing).
2. Measure spiral rod length. (Make sure rod is flush with screw hole at end of tube before measuring)
3. Identify the color of the bearing (e.g., white or red) and select our part # from the chart below.
4. Identify the appropriate carrier or other related accessories on chart provided below.

	ROD LENGTH	WHITE BEARING	RED BEARING
TUBE LENGTH	A	B	C
10"	11-5/8"	50720001	—
11"	12-5/8"	50720002	—
12"	13-5/8"	50720003	50720004
13"	14-5/8"	50720005	50720006
14"	15-5/8"	50720007	50720008
15"	16-5/8"	50720009	50720010
16"	17-5/8"	50720011	50720012
17"	18-5/8"	50720013	50720014
18"	19-5/8"	50720015	50720016
19"	20-5/8"	50720017	50720018
20"	21-5/8"	50720019	50720020
21"	22-5/8"	50720021	50720022
22"	23-5/8"	50720023	50720024
23"	24-5/8"	50720025	50720026
24"	25-5/8"	50720027	50720028
25"	26-5/8"	50720029	50720030
26"	27-5/8"	50720031	50720032
27"	28-5/8"	50720033	50720034
28"	29-5/8"	50720035	50720036
29"	30-5/8"	50720037	50720038
30"	31-5/8"	50720039	50720040
31"	32-5/8"	50720041	50720042
32"	33-5/8"	50720043	50720044
33"	34-5/8"	50720045	50720046

CARRIER

WHITE
PART # 50720047

BLACK
PART # 50720048

TOP SASH GUIDE

PART # 50720049

LOWER SASH CLIP

PART # 50720050

SASH CLIPS

OPPOSITE
PART # 50720051

BLACK
PART # 50720052

SASH CLIP

PART # 50720053

SASH CLIP

PART # 50720054

SASH CLIP

PART # 50720055

SASH CLIP

PART # 50720056

HARDWARE & TOILET PARTITIONS

74 SERIES 3/8" TUBE BALANCE AND ACCESSORIES

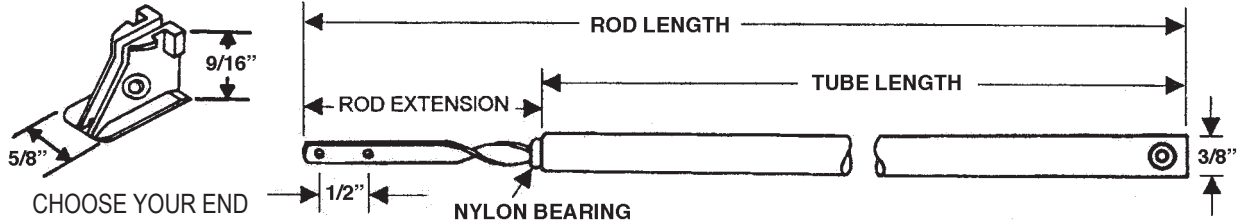

ORDERING INFORMATION

1. Measure metal tube length. (Do not include nylon bearing).
2. Measure spiral rod length. (Make sure rod is flush with screw hole at end of tube before measuring)
3. Identify the color of the bearing (e.g., white, red or blue) and select our part # from the chart below.
4. Identify the appropriate carrier or other related accessories on chart provided below.

Note: The difference between the 74 & 75 series is the hole center distance in the spiral rod.

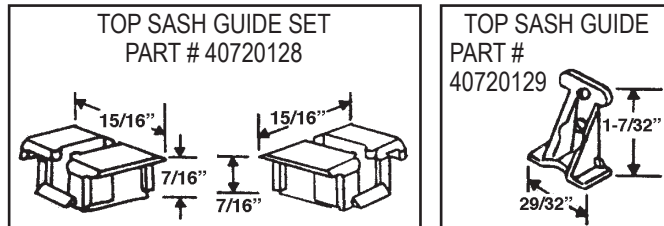
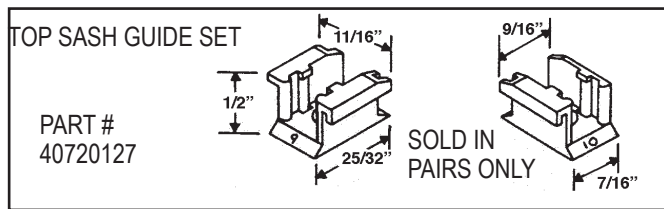
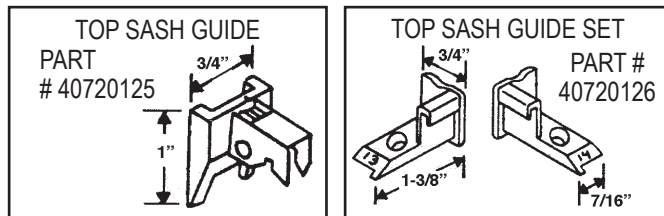
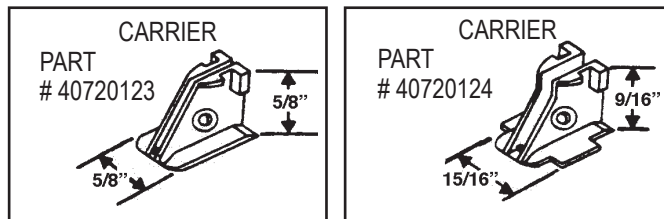
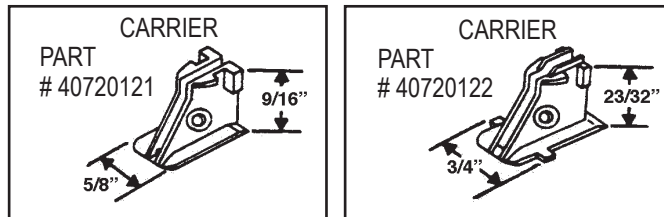

	ROD LENGTH	WHITE BEARING	RED BEARING	BLUE BEARING
TUBE LENGTH	A	B	C	D
10"	11-3/4"	50720057	50720058	—
11"	12-3/4"	50720059	50720060	—
12"	13-3/4"	50720061	50720062	—
13"	14-3/4"	50720063	50720064	50720065
14"	15-3/4"	50720066	50720067	50720068
15"	16-3/4"	50720069	50720070	50720071
16"	17-3/4"	50720072	50720073	50720074
17"	18-3/4"	50720075	50720076	50720077
18"	19-3/4"	50720078	50720079	50720080
19"	20-3/4"	50720081	50720082	50720083
20"	21-3/4"	50720084	50720085	50720086
21"	22-3/4"	50720087	50720088	50720089
22"	23-3/4"	50720090	50720091	50720092
23"	24-3/4"	50720093	50720094	50720095
24"	25-3/4"	50720096	50720097	50720098
25"	26-3/4"	50720099	50720100	50720101
26"	27-3/4"	50720102	50720103	
27"	28-3/4"	50720104	50720105	
28"	29-3/4"	50720106	50720107	
29"	30-3/4"	50720108	50720109	
30"	31-3/4"	50720110	50720111	
31"	32-3/4"	50720112	50720113	
32"	33-3/4"	50720114	50720115	
33"	34-3/4"	50720116		
34"	35-3/4"	50720117		
35"	36-3/4"	50720118		
36"	37-3/4"	50720119		
37"	38-3/4"	50720120		



HOUSTON
800/392-5066

ORLANDO
800/327-3022

GREENVILLE
800/476-2212

LOOK FOR US ON THE WEB AT: www.TMSSouth.com

HARDWARE & TOILET PARTITIONS

75 SERIES 3/8" TUBE BALANCE AND ACCESSORIES

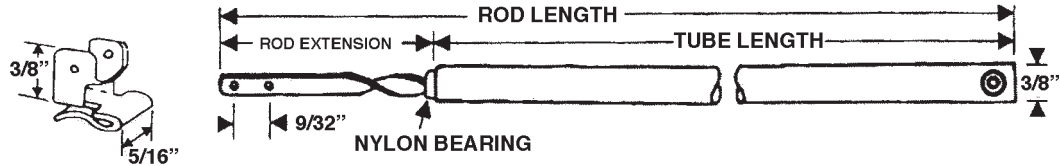

CHOOSE YOUR END

Note: The difference between the 74 & 75 series is the hole center distance in the spiral rod.

ORDERING INFORMATION

1. Measure metal tube length. (Do not include nylon bearing).
2. Measure spiral rod length. (Make sure rod is flush with screw hole at end of tube before measuring)
3. Identify the color of the bearing (e.g., white, red or blue) and select our part # from the chart below.
4. Identify the appropriate carrier or other related accessories on chart provided below.

	ROD LENGTH	WHITE BEARING	RED BEARING	BLUE BEARING
TUBE LENGTH	A	B	C	D
10"	10-9/16"	50720130	—	—
11"	11-9/16"	50720131	—	—
12"	12-9/16"	50720132	—	—
13"	13-9/16"	50720133	50720134	—
14"	14-9/16"	50720135	50720136	50720137
15"	15-9/16"	50720138	50720139	50720140
16"	16-9/16"	50720141	50720142	50720143
17"	17-9/16"	50720144	50720145	50720146
18"	18-9/16"	50720147	50720148	50720149
19"	19-9/16"	50720150	50720151	50720152
20"	20-9/16"	50720153	50720154	50720155
21"	21-9/16"	50720156	50720157	50720158
22"	22-9/16"	50720159	50720160	50720161
23"	23-9/16"	50720162	50720163	50720164
24"	24-9/16"	50720165	50720166	50720167
25"	25-9/16"	50720168	50720169	50720170
26"	26-9/16"	50720171	50720172	
27"	27-9/16"	50720173	50720174	
28"	28-9/16"	50720175	50720176	
29"	29-9/16"	50720177	50720178	
30"	30-9/16"	50720179	50720180	
31"	31-9/16"	50720181	50720182	
32"	32-9/16"	50720183	50720184	
33"	33-9/16"	50720185		
34"	34-9/16"	50720186		
35"	35-9/16"	50720187		
36"	36-9/16"	50720188		
37"	37-9/16"	50720189		

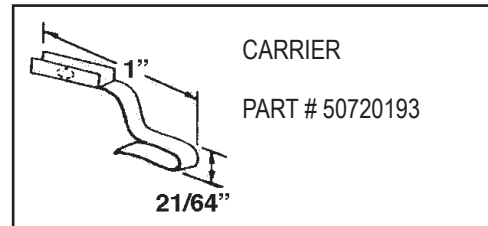
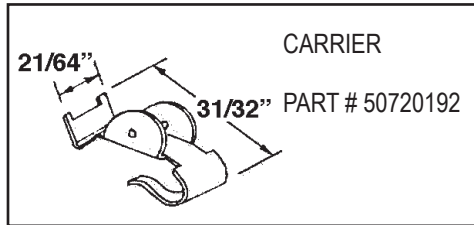
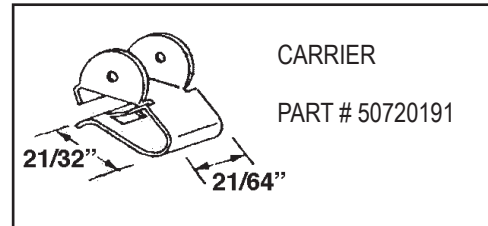
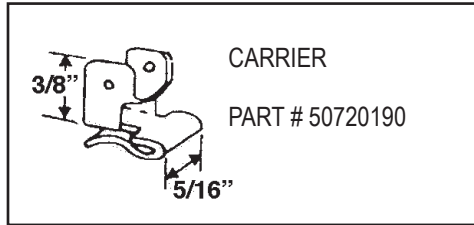

HARDWARE & TOILET PARTITIONS

76 SERIES 3/8" TUBE BALANCE

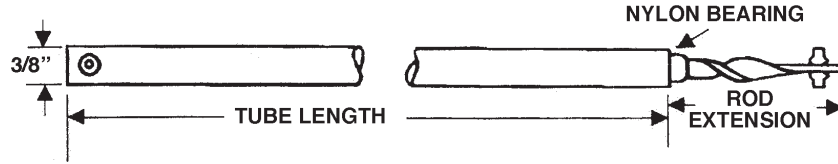

ORDERING INFORMATION

1. Measure metal tube length. (Do not include nylon bearing).
2. Measure spiral rod length. (Make sure rod is flush with screw hole at end of tube before measuring)
3. Identify the color of the bearing (e.g., white, red or blue) and select our part # from the chart below.
4. Identify the appropriate sash clips or other related accessories from illustrations below and at right.

	ROD LENGTH	WHITE BEARING	RED BEARING	BLUE BEARING
TUBE LENGTH	A	B	C	D
10"	10-5/8"	50720194	—	—
11"	11-5/8"	50720195	—	—
12"	12-5/8"	50720196	—	—
13"	13-5/8"	50720197	50720198	—
14"	14-5/8"	50720199	50720200	—
15"	15-5/8"	50720201	50720202	50720203
16"	16-5/8"	50720204	50720205	50720206
17"	17-5/8"	50720207	50720208	50720209
18"	18-5/8"	50720210	50720211	507202129
19"	19-5/8"	50720213	50720214	50720215
20"	20-5/8"	50720216	50720217	50720218
21"	21-5/8"	50720219	50720220	50720221
22"	22-5/8"	50720222	50720223	50720224
23"	23-5/8"	50720225	50720226	50720227
24"	24-5/8"	50720228	50720229	50720230
25"	25-5/8"	50720231	50720232	50720233
26"	26-5/8"	50720234	50720235	50720236
27"	27-5/8"	50720237	50720238	
28"	28-5/8"	50720239	50720240	
29"	29-5/8"	50720241	50720242	
30"	30-5/8"	50720243	50720244	
31"	31-5/8"	50720245	50720246	
32"	32-5/8"	50720247	50720248	
33"	33-5/8"	50720249		
34"	34-5/8"	50720250		
35"	35-5/8"	50720251		
36"	36-5/8"	50720252		
37"	37-5/8"	50720253		

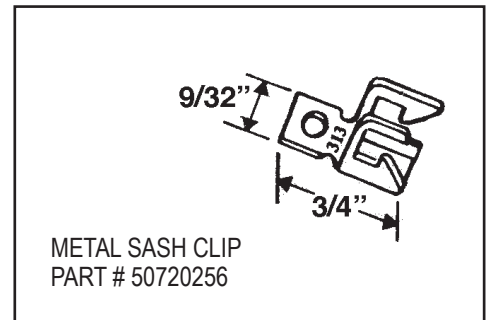
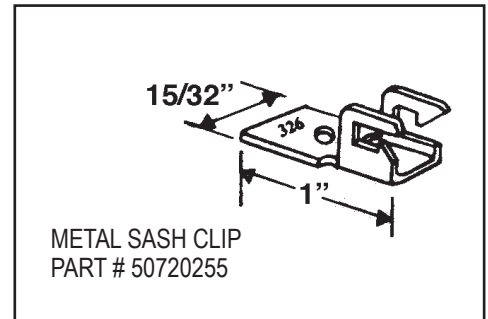
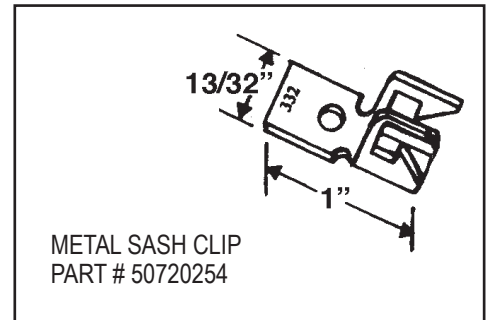

**TOTAL
MAINTENANCE
SOLUTIONS**

HOUSTON
800/392-5066

ORLANDO
800/327-3022

GREENVILLE
800/476-2212

LOOK FOR US ON THE WEB AT: www.TMSSouth.com

HARDWARE & TOILET PARTITIONS

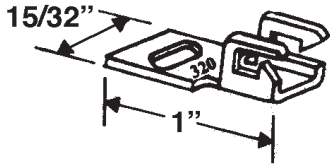

METAL SASH CLIP
PART # 50720257

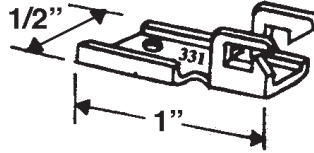

METAL SASH CLIP
PART # 50720258

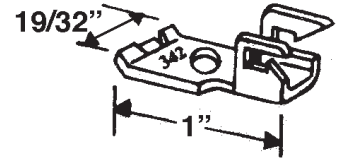

METAL SASH CLIP
PART # 50720259

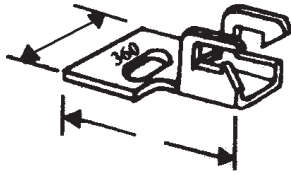

METAL SASH CLIP
PART # 50720260

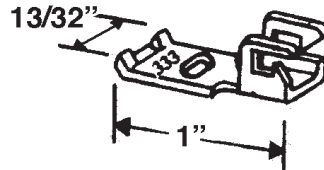

METAL SASH CLIP
PART # 50720261

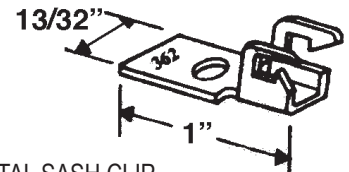

METAL SASH CLIP
PART # 50720262

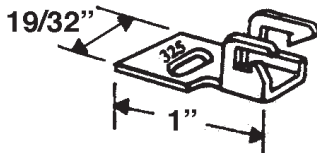

METAL SASH CLIP
PART # 50720263

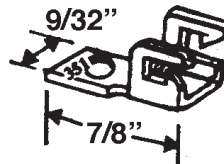

METAL SASH CLIP
NO LONGER AVAILABLE
USE PART # 50720256

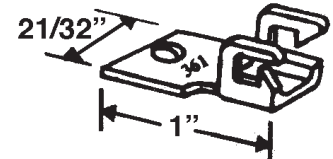

METAL SASH CLIP
PART # 50720264

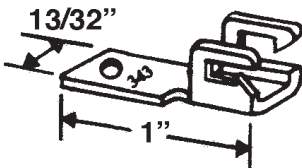

METAL SASH CLIP
PART # 50720265

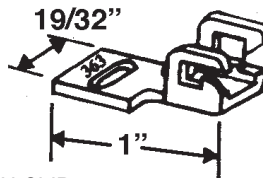

METAL SASH CLIP
PART # 50720266

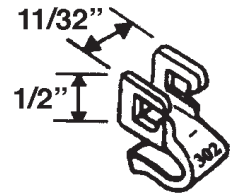

BRACKET
PART # 50720267

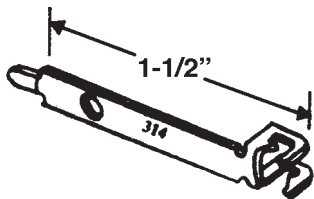

METAL SASH BRACKET
PART # 50720268

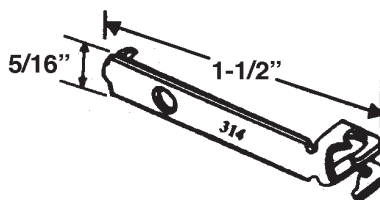

METAL SASH BRACKET
PART # 50720269

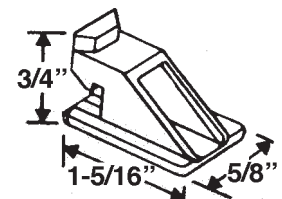

METAL SASH BRACKET
PART # 50720270

HARDWARE & TOILET PARTITIONS

83 SERIES 3/8" TUBE BALANCE

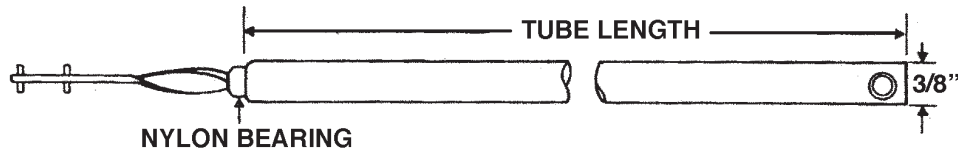

ORDERING INFORMATION

1. Measure metal tube length. (Do not include nylon bearing).
2. Measure spiral rod length. (Make sure rod is flush with screw hole at end of tube before measuring)
3. Identify the color of the bearing (e.g., white, red or blue) and select our part # from the chart below.
4. Identify the appropriate carrier or other related accessories from illustrations below and at right.

	WHITE BEARING	RED BEARING	BLUE BEARING
TUBE LENGTH	A	B	C
10"	50720271	—	—
11"	50720272	—	—
12"	50720273	—	—
13"	50720274	50720275	—
14"	50720276	50720277	—
15"	50720278	50720279	50720280
16"	50720281	50720282	50720283
17"	50720284	50720285	50720286
18"	50720287	50720288	50720289
19"	50720290	50720291	50720292
20"	50720293	50720294	50720295
21"	50720296	50720297	50720298
22"	50720299	50720300	50720301
23"	50720302	50720303	50720304
24"	50720305	50720306	50720307
25"	50720308	50720309	50720310
26"	50720311	—	—
27"	50720312	—	—
28"	50720313	—	—
29"	50720314	—	—
30"	50720315	—	—
31"	50720316	—	—
32"	50720317	—	—
33"	50720318	—	—

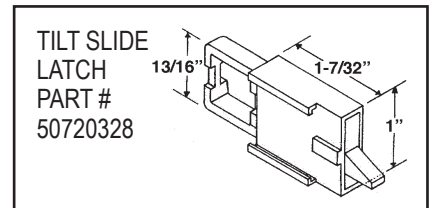
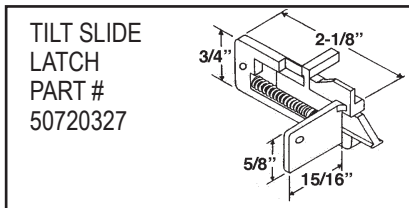
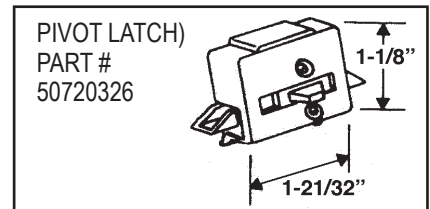
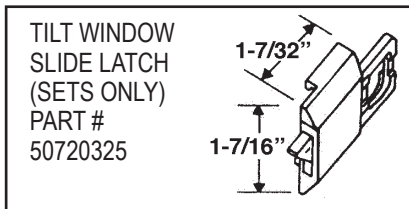
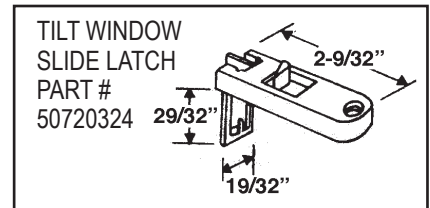
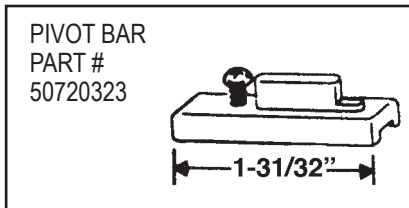
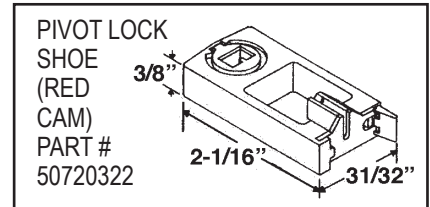
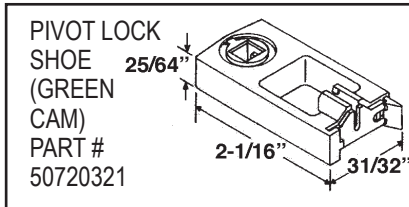
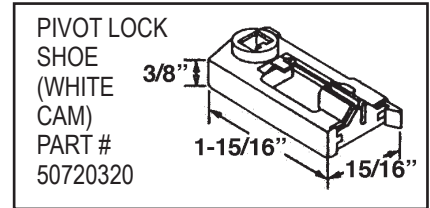
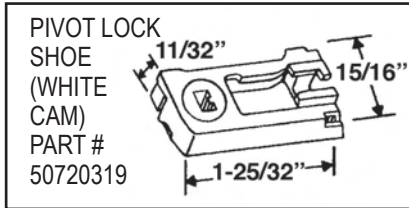

HARDWARE & TOILET PARTITIONS

83 SERIES 3/8" TUBE BALANCE

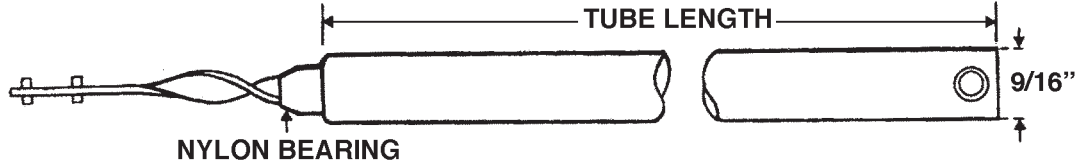

ORDERING INFORMATION

1. Measure metal tube length. (Do not include nylon bearing).
2. Measure spiral rod length. (Make sure rod is flush with screw hole at end of tube before measuring)
3. Identify the color of the bearing (e.g., black, red or blue) and select our part # from the chart below.
4. Identify the appropriate carrier or other related accessories from illustrations below and at right.

	RED BEARING	BLUE BEARING	BLACK BEARING
TUBE LENGTH	A	B	C
12"	50720329	50720330	—
13"	50720331	50720332	—
14"	50720333	50720334	—
15"	50720335	50720336	—
16"	50720337	50720338	—
17"	50720339	50720340	50720341
18"	50720342	50720343	50720344
19"	50720345	50720346	50720347
20"	50720348	50720349	50720350
21"	50720351	50720352	50720353
22"	50720354	50720355	50720356
23"	50720357	50720358	50720359
24"	50720360	50720361	50720362
25"	50720363	50720364	50720365
26"	50720366	50720367	50720368
27"	50720369	50720370	50720371
28"	50720372	50720373	50720374
29"	50720375	50720376	50720377
30"	50720378	50720379	50720380
31"	50720381	50720382	50720383
32"	50720384	50720385	50720386
33"	50720387	50720388	50720389
34"	50720390		50720391
35"	50720392		50720393
36"	50720394		50720395
37"	50720396		50720397
38"	50720398		50720399
39"	50720400		50720401

PIVOT LOCK SHOE
(NYLON CAM)

NO LONGER AVAILABLE
USE PART # 50720402

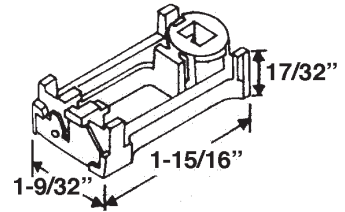

PIVOT LOCK SHOE
(BLUE CAM)
PART # 50720402

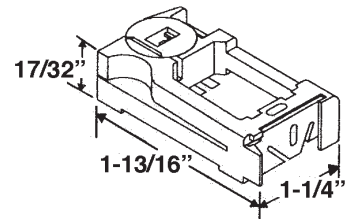

PIVOT LOCK SHOE
(WHITE CAM)
PART # 50720403

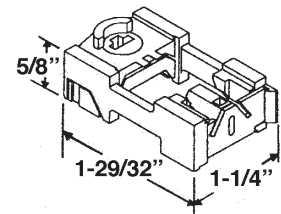

PIVOT LOCK SHOE
(DIE CAST CAM)
PART # 50720404

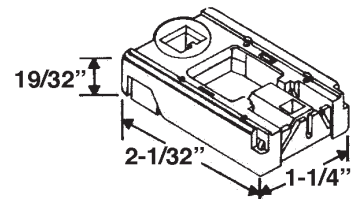

PIVOT LOCK SHOE
(BLACK CAM)
PART # 50720405

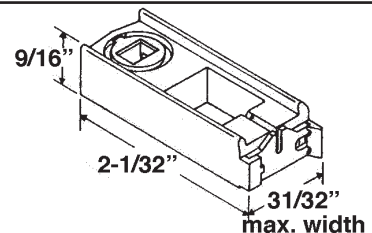

**TOTAL
MAINTENANCE
SOLUTIONS**

HOUSTON
800/392-5066

ORLANDO
800/327-3022

GREENVILLE
800/476-2212

LOOK FOR US ON THE WEB AT: www.TMSSouth.com