

**LAVATORY FAUCETS**

# 40002103  
American Standard Heritage  
4" centerset with dodecahedron  
handles and pop-up

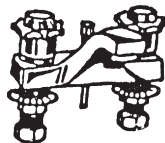

# 40002104  
American Standard Heritage  
4" centerset with brass crown  
handles less pop-up



# 40100194  
B&K Faucet, 4" washerless w/ acrylic  
handles  
# 40100172  
Same as above, with pop-up



# 40100185  
Central  
Brass 4"  
centerset  
with 4" cast  
brass wrist  
handles.  
No pop-up

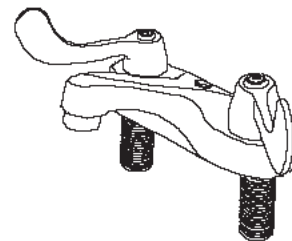

# 40100183  
Central Brass solid cast brass body, 4"  
centers with pop-up

# 40100041  
Same as 40100183  
without pop-up

# 40151138  
Same as 40100183  
with chain & stopper

# 40151133  
Central Brass solid cast  
brass body with 4-5/8"  
extended spout

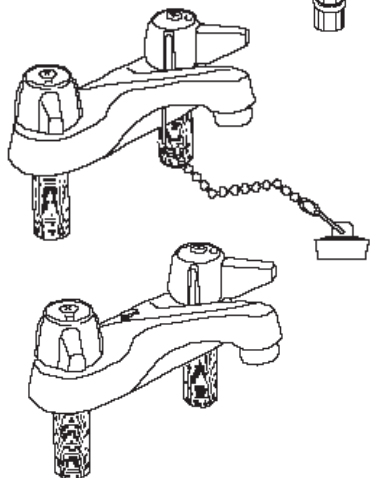
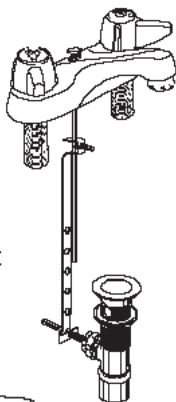

# 40100121  
Central Brass 4"  
centerset  
vandal-resis-  
tant cap.  
External cycle  
adjustment.

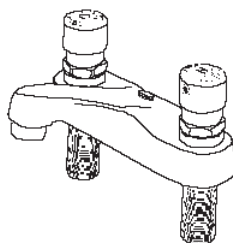

# 40100036  
Kohler Triton  
4" centerset  
less pop-up



# 40100168  
Delta 4" centerset Crystal-Like handle  
with pop-up

# 40220502  
Same as 40100168 less  
pop-up

# 40100116  
With ADA lever  
handle -  
less pop-up



# 40100184  
Central Brass shelf Back cast brass body  
adjustable centers 4" to 6" with pop-up

# 40100039  
Same as 40100184 without pop-up

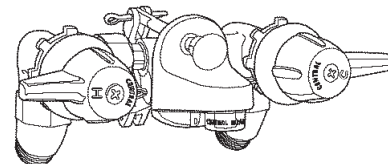

# 40151178  
Central Brass 45 degree slant back with  
adjustable centers 4" to 6"

# 40151179  
Same as 40151178 with pop-up

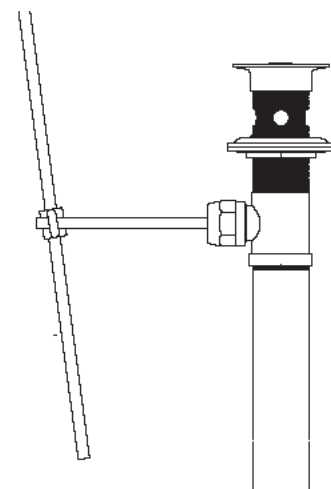
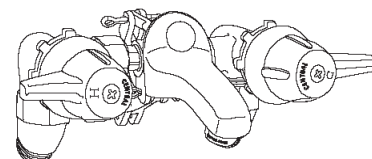

# 40100182  
Central Brass widespread faucet with adjustable  
centers 6" to 24" with pop-up

# 40100159  
Central Brass widespread faucet. Adjustable cen-  
ters 6" to 24" less pop-up

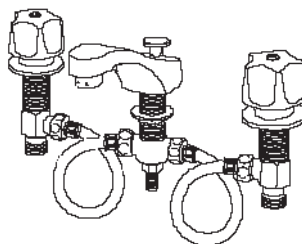

**TOTAL  
MAINTENANCE  
SOLUTIONS**

**HOUSTON**  
800/392-5066

**ORLANDO**  
800/327-3022

**GREENVILLE**  
800/476-2212

LOOK FOR US ON THE WEB AT: [www.TMSSouth.com](http://www.TMSSouth.com)

**FAUCETS**

# 40100222  
 B&K Faucet  
 4" centerset, all brass underbody  
 less pop-up  
 # 40100192  
 Same as 40100222 with pop-up  
 # 40682200  
 Same as 40100222 with acrylic handles



**LAVATORY FAUCETS**

# 40684411  
 TMS Single handle 4" centerset with pop-up  
 # 40684410  
 Less pop-up  
 # 40100160  
 Less pop-up with lever  
 #40684425  
 w/ pop-up & lever



# 40100189  
 Gerber solid cast brass body, 4" centers  
 # 40294340  
 With 4" Wrist handles  
 # 40100169  
 Same as 40100189 with pop-up



**HUNTINGTON BRASS FAUCETS**



**4" TWO HANDLE FAUCET**  
 "Wind" Style  
 Metal Handles  
 Brass Washerless Cartridge  
 Brass Pop-Up  
 Chrome: PART # 40100205

**2-HANDLE LAUNDRY FAUCET**  
 Metal handles  
 4" center set laundry faucet  
 Price Pfister interchangeable compression stems  
 PART # 40404030



**2-HANDLE LAVATORY FAUCET**  
 Metal wrist blade handles  
 "Reliaflow" 4" center set  
 Brass Pop-up  
 Quarter turn washerless cartridge  
 PART # 40404040

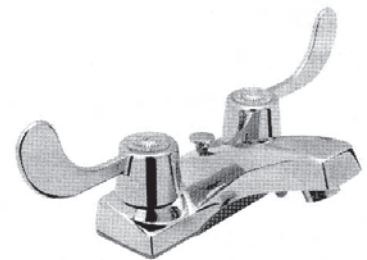

**2-HANDLE BAR FAUCET**  
 Metal wrist blade handles  
 4" centerset bar faucet  
 7" high swing spout  
 PART # 40404020



MORE PRODUCTS ARE AVAILABLE FROM



CALL US FOR MORE INFORMATION!



HOUSTON  
 800/392-5066

ORLANDO  
 800/327-3022

GREENVILLE  
 800/476-2212

LOOK FOR US ON THE WEB AT: [www.TMSSouth.com](http://www.TMSSouth.com)

**FAUCETS**

**SINK FAUCETS**

# 40100259  
Central Brass cast brass top mount with 8" tube spout – 8" centers



# 40100260  
Same as 40100259 with hose & spray

# 40100198  
Central Brass cast brass top mount with 8" tube spout – 6" centers

# 40100199  
Same as 40100198 with hose & spray

# 40100227  
B&K Faucet washerless kitchen w/ acrylic handles



# 40100193  
Same as above with spray

# 40100174  
Central Brass 8" wall mount with 6" tube spout. 1/2" FIP union connection

# 40100161  
Same as 40100174 with 12" tube spout

#40100196  
8" spout, w/ soap dish

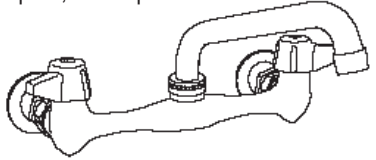

# 40100209  
Central Brass cast brass top mount with 8" centers



# 40100210  
Same as 40100209 with hose & spray

# 40160128  
T&S Brass deck mounting 8" spread with 6" spout

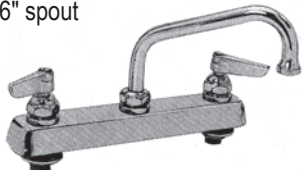

# 40160123  
Same with 8" spout

# 40160116  
Same with 12" spout

# 40160110  
Same less spout

# 40100338  
TMS 8" wall mount cast brass faucet. 1/2" FIP union connection. 12" cast brass spout.

# 40100339  
TMS economy 8" wall mount cast brass faucet with 12" tube spout

# 40100187  
Gerber all brass underbody with 8" tube spout – 8" centers



# 40100188  
Same as 40100187 with hose & spray

# 40100257  
Central Brass concealed ledge 8" cast brass spout – 8" centers

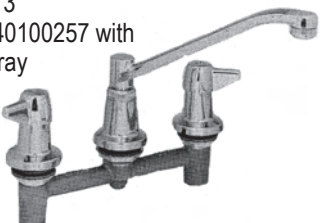

# 40150073  
Same as 40100257 with hose & spray



# 40100216  
B&K Faucet all brass underbody with 8" cast brass spout – 8" centers



# 40682302  
Same as 40100216 with hose & spray

# 40100115  
Delta single lever with hose & spray



# 40220100  
Same as 40100115 without hose & spray

# 40160070  
T&S Brass wall mount 8" centers with 1/2" FIP union connection & 12" spout

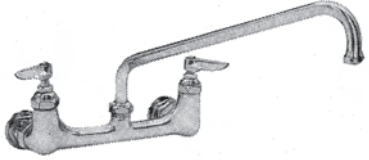

# 40688820  
TMS single lever 8" cast brass spout. 3/8" O.D. copper tube supplies.



# 40100208  
Same as 40688820 with hose & spray

# 40160153  
T&S Brass slash back mounting 8" spread with 6" spout.

# 40160111 Same less spout

# 18861126  
Same with 8" spout

# 40160084  
Same with 12" spout



**TOTAL  
MAINTENANCE  
SOLUTIONS**

**HOUSTON**  
800/392-5066

**ORLANDO**  
800/327-3022

**GREENVILLE**  
800/476-2212

LOOK FOR US ON THE WEB AT: [www.TMSSouth.com](http://www.TMSSouth.com)

## FAUCETS

### SINK FAUCETS

Single Sink Faucet-hose End.  
Polished CP  
brass  
# 57753104  
1/2" MIP



Central Brass Basin Cock.  
Solid cast brass.  
# 40150188  
Cold index  
# 40100200  
Hot index



Single Sink Faucet.  
Plain end Polished  
CP brass with adj.  
flange  
# 57753112  
1/2" MIP



Single Sink Faucet-hose End.  
Plain brass.  
40300176  
1/2" MIP  
40350081  
3/4" MIP



TMS Basin Cock CP  
Cast brass.  
# 40100224  
Hot & Cold basin cock  
# 40100173  
H&C basin cock w/ aerator



Single Sink  
Faucet-hose End.  
Polished CP brass  
# 57753108  
1/2" MIP  
# 57753110  
3/4" MIP



Single Sink Faucet-hose End. CP rough  
brass with adj. flange  
# 40100256  
1/2" MIP

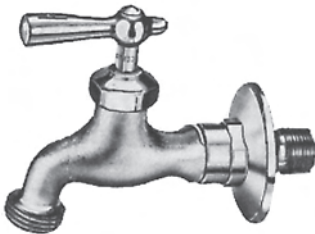

# 40100201  
Central Brass  
Self-Closing Basin Cock.  
Plain index.



Single Sink Faucet-  
hose End. Polished  
CP brass with  
flange  
# 57753114  
1/2" FIP



Central Brass Slow-Close  
Basin Cock with  
external cycle  
adjustment.  
# 40100202  
Cold index  
# 40150354  
Hot index



# 40151131  
Shampoo Fitting. Solid cast brass body,  
4" centers with bottom outlet.



## Did You Know?

TMS South is part of TMS, a group of strategically based MRO distributors in the United States who have combined their resources to bring unparalleled product knowledge and unbeatable service to our customers.

Our depth of regional experience allows us to give our customers exactly what they need quickly and easily. You will speak directly to an experienced service representative, not an order taker. We take the time to understand your unique regional problems and help to find efficient, superior Total Maintenance Solutions for your projects.



HOUSTON  
800/392-5066

ORLANDO  
800/327-3022

GREENVILLE  
800/476-2212

LOOK FOR US ON THE WEB AT: [www.TMSSouth.com](http://www.TMSSouth.com)

**CORAL COLLECTION FROM TMS**

**SINGLE LEVER "D"-TUBE KITCHEN FAUCET**

PART # 40100234 With White Spray  
 PART # 40100235 Without Spray



**TWO-HANDLE "D"-TUBE KITCHEN FAUCET**

PART # 40100236  
 With Euro-style, White Spray

PART # 40100237  
 Without Spray



**TWO-HANDLE LAVATORY FAUCET**

PART # 40100239  
 Less Pop-up

PART # 40101240  
 With Pop-up



**TWO-HANDLE WIDE SPREAD FAUCET WITH 6"-18" CENTERS**

PART # 40100335 With Pop-up  
 PART # 40100336 Less Pop-up

**TWO-HANDLE HIGH-RISE KITCHEN FAUCET**

PART # 40100238 8" Spread, 12-1/4" hi-rise spout, chrome finish with spray



**TWO-HANDLE HI-RISE BAR FAUCET**

PART # 40100337 4" Spread, 11-1/4" hi-rise spout, chrome finish



**SINGLE LEVER LAVATORY FAUCET**

PART # 40100241 Less Pop-up  
 PART # 40100242 With Pop-up



**TOTAL MAINTENANCE SOLUTIONS**

**HOUSTON**  
 800/392-5066

**ORLANDO**  
 800/327-3022

**GREENVILLE**  
 800/476-2212

LOOK FOR US ON THE WEB AT: [www.TMSSouth.com](http://www.TMSSouth.com)

## FAUCETS

# 40100157

American Standard service sink faucet. 1/2" FIP inlets on 8" centers with vacuum breaker & 3/4" hose thread outlet.

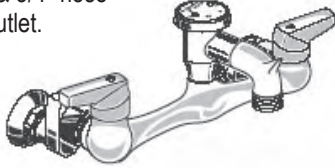

# 40150465

Laundry Faucet, cast brass body, 3-1/2" centers, 6" tube spout, rough brass.

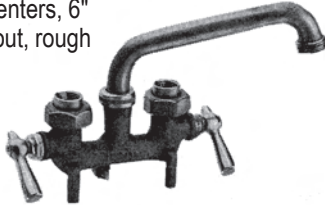

# 40100044

Kohler service sink faucet. 1/2" FIP inlets on 8" centers with vacuum breaker and 3/4" hose thread outlet.



## SERVICE SINK FAUCETS

# 40100197

Central Brass wall mount service sink faucet. 8" spread with 1/2" FIP union flange & 3/4" hose nozzle outlet.



# 40100038

Speakman service sink faucet. 1/2" eccentric inlets with adjustable threaded wall flanges on 8" centers. Integral stops, 3/4" hose end nozzle with vacuum breaker.



# 40100046

Same as above with wall brace



# 59981420

Washing Machine shut-off valve. Ball valve action. 1/2" SWT inlet and 3/4" hose outlets.

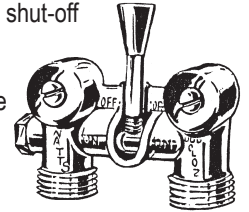

# 40160085

T&S Service Sink Faucet 1/2" IPS eccentric inlets. 8" centers, 4-3/4" from wall to center of outlet. Rough chrome plated finish. Vacuum breaker nozzle with pail hook & 3/4" garden hose thread.



# 40100186

TMS Service Sink Faucet

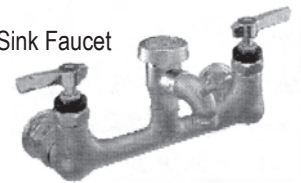

## BATH AND SHOWER VALVES

# 40713812

Tub & shower diverter, 3-3/8" centers for concealed shower.



# 40100178

Self close, lever shower valve w/ chain

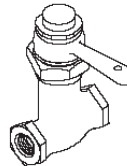

# 40100118

Utility shower with cast brass body, 3-1/2" centers, 22-1/2" galvanized riser, shower head, soap dish & 1/2" FIP unions.

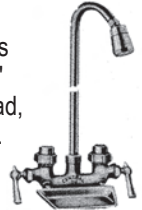

# 40100211

Tub Valve – Two handle cast brass body, 1/2" FIP unions on 6" centers.



# 40520043

Leg Tub fitting with 3-3/8" centers, cast brass body.

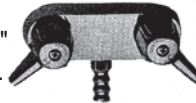

# 40520033

Three Valve cast brass body, 1/2" FIP unions on 8" centers.

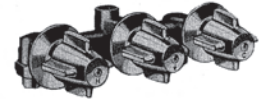

# 40520034

Three Valve cast brass body, 1/2" FIP unions on 11" centers.

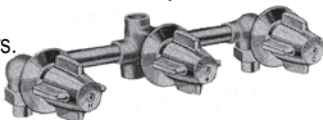

## FOOD SERVICE FAUCETS IN SECTION 2

# 40520032

Tub or Shower valve. Two valve cast brass body, 1/2" FIP unions on 8" centers.

# 40520035

Same as above but with built-in transfer valve for use as tub & shower valve.

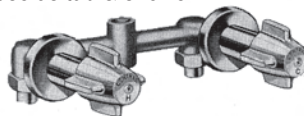

# 40520016

Three Valve cast brass body, 1/2" FIP unions on 8" centers, Zamack spout, shower head, arm and flange.



**TOTAL  
MAINTENANCE  
SOLUTIONS**

HOUSTON  
800/392-5066

ORLANDO  
800/327-3022

GREENVILLE  
800/476-2212

LOOK FOR US ON THE WEB AT: [www.TMSSouth.com](http://www.TMSSouth.com)

**HOSPITAL & MEDICAL FAUCETS**

# 18866010

T&S Brass surgical sink faucet. Deck mount 8" centers with 1/2" outlet. Rigid gooseneck with 4" wrist handles.



# 18866050

T&S Brass surgical sink faucet with loose key stops. 8" centers with 4" wrist handles. 9-3/4" wall to center of outlet.



# 18866030

T&S Brass surgical sink faucet with built-in stops. Wall mount 8" centers with 4" wrist handles & rigid gooseneck.

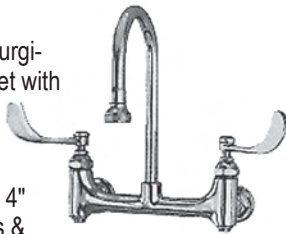

# 18866020

T&S Brass surgical sink faucet wall mount 8" centers. 4" wrist handles & rigid gooseneck. Without integral stops.

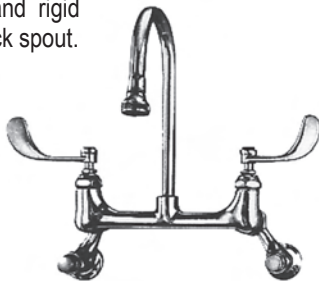

# 18866042

T&S Brass surgical sink faucet with adjustable inlets & loose key stops. 4" wrist handles and rigid gooseneck spout.

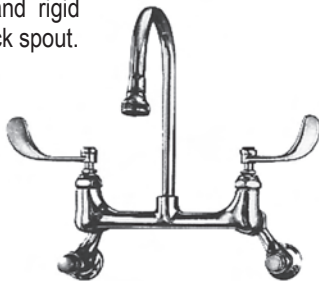

# 18866012

T&S Brass medical lavatory faucet 4" centers with 4" wrist handles.

# 18867025

Same as 18866012 with spray outlet.



# 18867022

T&S Brass medical lavatory faucet with pop-up waste. 4" centers and 4" wrist handles with rigid gooseneck spout.

# 40160155

Same as above without pop-up

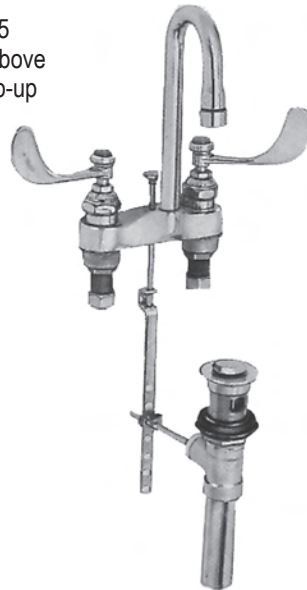

# 18860038

T&S Brass knee action valve. 1/2" FIP inlet and 2-1/2" centers and 1/2" FIP outlet.



# 40160115

T&S Brass medical lavatory faucet with 8" adjustable centers. 6" wrist handles and rigid spout.



#18868020

Same as 18868010 with pop-up waste.

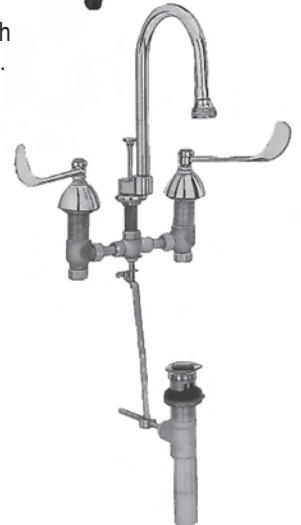

# 40160174

Widespread hospital faucet Includes flex lines that allow variable center-to-center measurement



**TOTAL  
MAINTENANCE  
SOLUTIONS**

**HOUSTON**  
800/392-5066

**ORLANDO**  
800/327-3022

**GREENVILLE**  
800/476-2212

LOOK FOR US ON THE WEB AT: [www.TMSSouth.com](http://www.TMSSouth.com)

**FAUCETS**

**HOSPITAL & MEDICAL FAUCETS**

# 40160076  
T&S Brass double pedal valve for floor mount. 1/2" FIP inlet on 2-1/2" centers



#18860046  
Single pedal valve for floor mounting.



# 18860045  
T&S Brass double pedal valve, wall mounted with long pedals. 1/2" FIP inlets on 2-1/2" centers and 1/2" FIP outlet on top.



# 40160071  
T&S Brass Pre-Rinse Spray with 44" flexible stainless steel hose.



# 18860043  
T&S Brass double pedal valve, wall mounted with long pedals. 1/2" FIP inlets on 2-1/2" centers and 1/2" FIP outlet on top.



# 18860048  
T&S Brass single pedal valve, wall mounted with straight stop.



# 18860044  
T&S Brass swivel gooseneck, wall mounted 3/8" FIP inlet.



# 18860060  
T&S Brass bedpan washer with extended spray outlet. Five foot rubber hose. 1/2" MIP inlet, no self-closing valve. Overall 79"



# 18860042  
T&S Brass rigid gooseneck spout, deck mounted. 10" high with 5" clearance deck to stream. Shank of base is 1/2" MIP with 1/4" MIP tailpiece.



Concealed Deck Mount Widespread Faucet with 5" Cast Spout and 4" Wrist Handles

PART # 40451018



Concealed Deck Mount Widespread Faucet with 3-1/2" Rigid Gooseneck Spout and 4" Wrist Handles

PART # 40451019



**SANIGUARD** *Encore*

4" Deck Faucet with Rigid Gooseneck, 4" Wrist Handles

PART # 40451017



4" Deck Faucet with Cast Spout and 4" wrist blades.

PART # 40451016

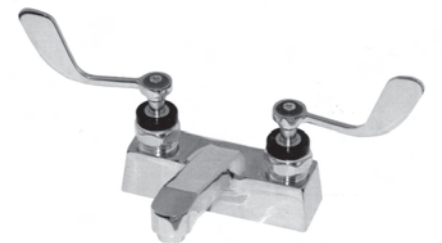

**SANIGUARD** *Encore*

8" Widespread Cast Spout Faucet

PART # 40310017



**WHAT IS SANIGUARD?**  
See page 9-13



**FAUCETS**

**LABORATORY SERVICE FITTINGS**

# 18860209  
Ground key hose cock.  
3/8" MIP inlet. Specify  
gas, air  
or vacuum.  
Max 30 PSI.

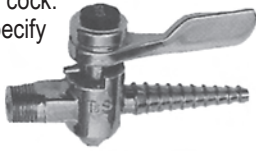

# 18860200  
Needle valve-3/8" MIP inlet.  
Specify service desired.  
For fine control of rare  
gases & standard  
services.



# 18860331  
Double Ledge  
Faucet. 3/8"  
gooseneck.  
1/4" MIP  
union tail-  
pieces on 4"  
centers.



# 18860332  
Same as above  
with vacuum  
breaker gooseneck.

# 18860214  
Turret with Hose Cock 3/8" FIP bottom  
inlet. Specify gas, air or vacuum.

# 18860215  
Two outlets at 90 degrees

# 18860216  
Two outlets at 180 degrees

# 18860217  
Three outlets

# 18860218  
Four outlets

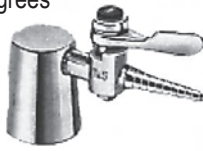

# 18860219  
Turret with Needle  
Valve  
3/8" FIP inlet.  
Specify  
service.

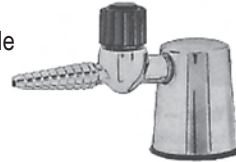

# 18860221  
Double Panel  
Flange with two  
Hose Cocks.  
3/8" FIP  
inlet,  
ground  
key hose cocks. Specify service.



# 18860350  
Single Sink Faucet. 3/8" gooseneck with  
1/2" FIP inlet. Specify hot or cold.

# 18860351  
Same as  
above  
except  
with  
vacuum  
breaker  
goose-  
neck

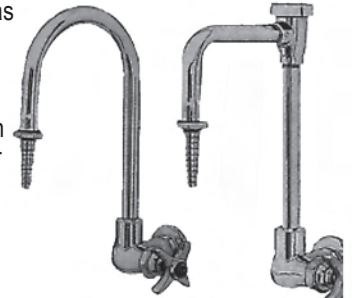

# 18860330  
Straight Steam Stop with  
angle tip. 3/8" MIP inlet.

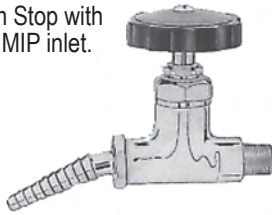

# 18860210  
Laboratory Turret 3/8" FIP bottom  
inlet and 3/8" FIP side outlet.  
# 18860208  
Same as above with 2 outlets at  
180 degrees.



# 18860034  
Single  
Ledge Fau-  
cet. 3/8"  
goose-  
neck  
with 1/2"  
shank-1/4" MIP  
union tailpiece.



# 18860335  
Same as above  
except with vacuum breaker  
gooseneck.

# 18860347  
Sink Mixing Faucet. 3/8"  
gooseneck, 1/2" FIP  
inlets on 8" centers.

# 18860348  
Same as above  
except with  
vacuum  
breaker  
goose-  
neck.



# 18860336  
Double Ledge  
Faucet with  
Taper Body Style.  
3/8" gooseneck, 1-  
1/8" shank  
with 1/4" MIP union  
tailpiece.

# 18860337  
Same as above  
except with  
vacuum  
breaker  
goose-  
neck.



# 18860319  
Straight Stop. 3/8" MIP inlet.  
Specify air, gas, or vacuum.

# 40160117  
Same as above for water.  
Specify hot or cold.



# 18860358  
Vertical Sink Mixing  
Faucet. 3/8" vacuum  
breaker gooseneck.  
1/2" FIP inlets on 3"  
vertical centers.

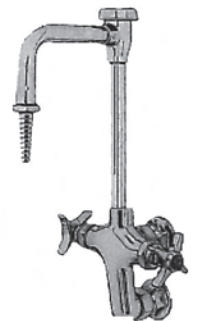

**FAUCETS**

**LABORATORY SERVICE FITTINGS**

# 18860341  
Ledge Mixing Faucet. 3/8" gooseneck.  
1/2" FIP inlets on 8" centers.

# 18860342  
Same as above except with vacuum  
breaker gooseneck.



# 18860360  
Combination Gas & Water Fixture  
with Hose Cocks. 3/8" FIP inlets  
for water & gas. Specify service  
gas, air or vacuum.



# 18860380  
PVC Single Ledge  
Faucet Compression  
Type. Rigid  
gooseneck.  
3/8" FIP inlet.



# 18860365  
Single Self-  
Closing Sink  
Faucet. 3/8"  
gooseneck.  
1/2" FIP inlet.  
Specify hot or  
cold index.



# 18860349  
Single  
Ledge  
Faucet with  
Taper Style  
Body. 3/8"  
gooseneck.  
1/2" shank with  
1/4" MIP union  
tailpiece.

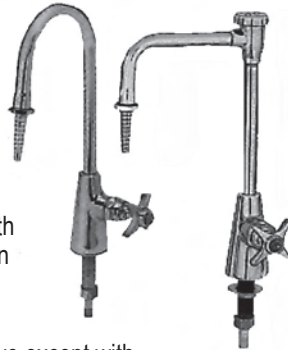

# 18860352  
Same as above except with  
vacuum breaker gooseneck.

# 18860385  
PVC Single Ledge Faucet Self-Clos-  
ing 3/8" FIP inlet. Dual lever control for  
manual or self-closing  
operations.



#18860353  
Single Ledge Faucet. 9" swing nozzle.  
1/2" shank with 1/4" MIP union tailpiece.  
Specify hot or cold.



# 18860355  
Sink Mixing Faucet. 9" swing nozzle. 1/2"  
FIP inlets on 8" centers.

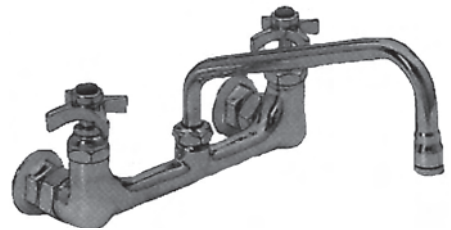

**Did You Know?**

**Then...**

- Hippocrates, known as the father of medicine, directed people in Greece to boil and strain their water before drinking it.

**Now...**

- The first United States water plant with filters was built in 1972 in Poughkeepsie, NY
- In 1908, Jersey City, New Jersey and Chicago, Illinois were the first water supplies to be chlorinated in the US

**FAUCETS**

**FOOD SERVICE FITTINGS**

# 18860011  
T&S Brass Pot & Glass Filler. Complete with 5 ft. hose and automatic shut-off valve.



# 40100176  
Cast Brass Bar faucet  
4" centers with swivel  
gooseneck spout



# 40160128  
T&S Brass Workboard faucet. 1/2" MIP shanks on 8" centers for deck mounting with 6" spout.

# 40160123  
With 8" spout

# 40160116  
With 12" spout



# 40160121  
T&S Brass Bar Sink faucet. 3-1/2" centers with 6" spout. Shanks 1/2" MIP - 1-1/2" long.

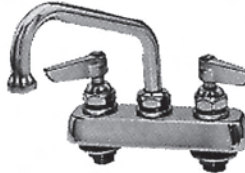

# 40160153  
T&S Brass Workboard faucet. 1/2" MIP shanks on 8" centers for splashback mounting with 6" spout.  
18861126 - with 8" spout  
40160084 - with 12" spout

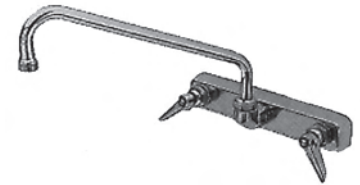

# 40160072  
T&S Brass "BIG-FLO" faucet. For pot sinks or kettles. 12" spout, 8" centers with 3/4" FIP eccentric union. Splashback mtng.

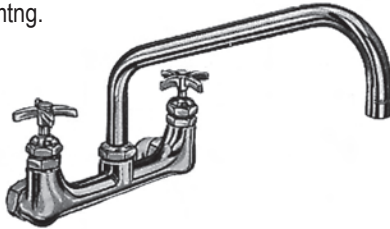

# 18860096  
T&S Brass Bar Sink faucet. 3-1/2" centers with 6" spout. Shanks 1/2" MIP - 1-1/2" long. For splashback mounting.



# 18860021  
T&S Brass Workboard Faucet with S/S Hose & Spray Valve. 1/2" shanks on 8" centers for splashback mounting. Comes with 8" spout with positive diverter for spray nozzle.



# 40100120  
Single Bar faucet. Cast brass body. Spout with stream former.

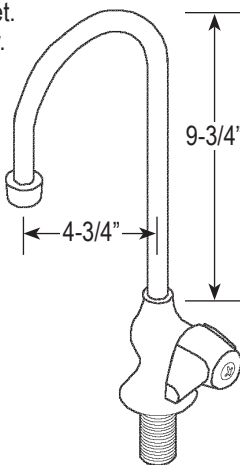

**MORE T&S SPOUTS ON PAGE 2-20**

# 40160092  
T&S Brass Bar Sink faucet. 4" centers with 6" spout. Shanks 1/2" MIP - 1-1/2" long. For splashback mounting.



# 40160077  
T&S Brass Bar Sink faucet. 4" centers with 6" spout. Shanks 1/2" MIP - 1" long.



# 40150281  
Single Bar Faucet. Cast brass body. Spout with stream former.

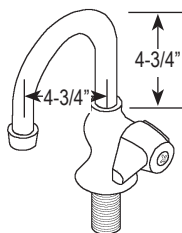

# 40150327  
Glass Filler Pedestal type, cast brass body, 1/2" MIP shank.



# 40150393  
Glass Filler Push Button Type, 3/8" FIP inlet.

# 40681195  
Economy glass filler



**FAUCETS**

**FOOD SERVICE FITTINGS**

# 40160071

T&S Brass Pre-Rinse Spray with flexible S/S hose. 48" overall, 44" hose.

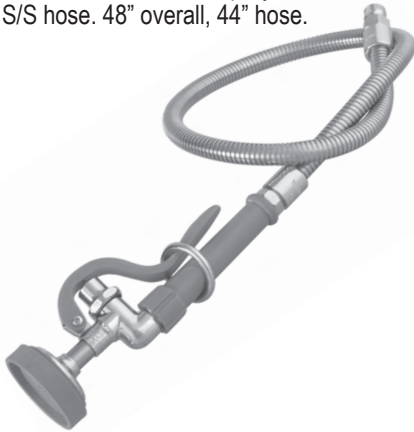

# 40160156

T & S Brass Pre-Rinse Hose with energy efficient spray. 44" hose.

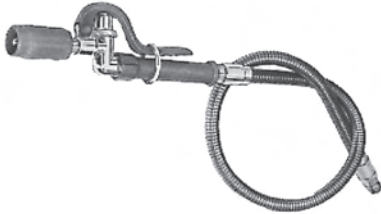

# 18860015

T&S Brass Pre-Rinse Hose. For under-counter, back-bar or soda fountains. *SHOULD NOT* be used where water temperature exceeds 130°F. 42" overall.

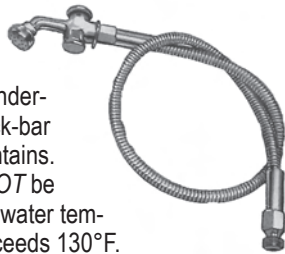

# 18860013

T&S Brass Pre-Rinse Hose. Same as 18860015 but with small aerator head in place of small spray head. 42" overall.

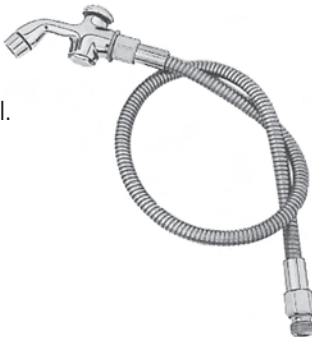

# 40160083

T&S Brass Add-On faucet. For use with Pre-Rinse units. Unit comes with 12" spout.

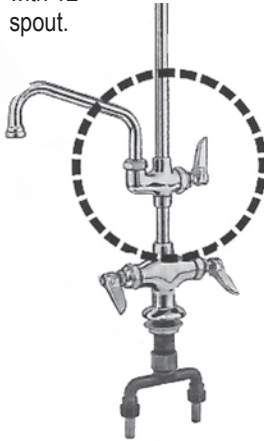

# 40100113

T&S Brass Pre-Rinse Unit. Complete unit with mixing faucet with 1/4" tailpiece on 4" centers. For deck mount installation. 44" hose, 24" riser, 18" braided supply line.

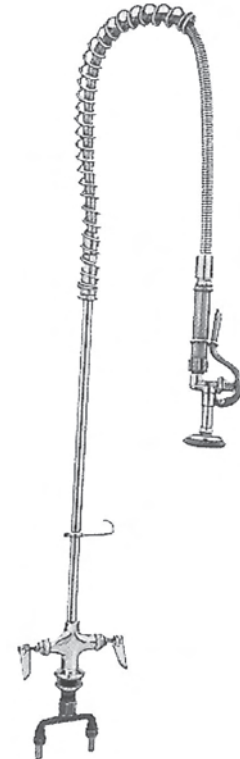

# 18860024

T&S Brass Pre-Rinse Unit Complete unit with mixing faucet on 8" centers for deck mount. 44" hose.



# 18860019

T&S Brass Pre-Rinse Unit. Complete unit with mixing faucet for deck mount installation. Unit has swivel gooseneck for increased coverage. 32" riser, 20" hose.



# 40100114

T&S Brass Pre-Rinse Unit Complete unit with mixing faucet on 8" centers for splashback installation.

# 18860017

Same as above but with overhead swivel goose-neck.

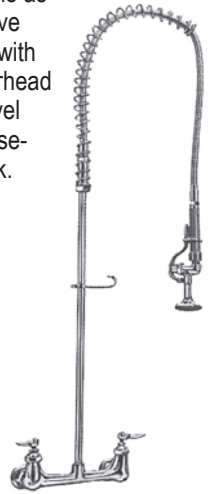

# 40160122

T&S Brass Pedestal Glass Filler 1/2" MIP shank 2" long.

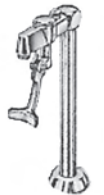

# 18860115

T&S Brass Glass & Pitcher Filler 6" swing spout. 1/2" MIP shank 2" long.

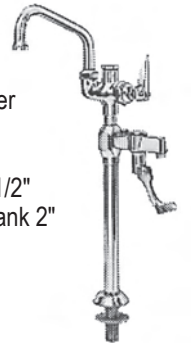

# 18860116

T&S Brass Reel Kleen Unit. Spray nozzle and 35 feet of hose.



**FAUCETS**

**FOOD SERVICE FITTINGS FROM COMPONENT HARDWARE GROUP**

**BACKSPLASH FAUCET**

- NSF Listed
- New easy 1/4 Turn Full Open Feature
- The only 4" faucet with built-in check valves, to prevent back flow and offer positive seal
- High commercial quality
- International color coded hot and cold identifiers
- Shown with optional wrist blade handles (no. K50-0001)
- Solid heavy-duty cast bodies with Swivel Goose-neck spout



PART # 40451020

**WALL MOUNT FAUCET WITH SWIVEL GOOSENECK**

- NSF listed
- New easy 1/4 Turn full open feature
- Furnished with both optional aerator and bubbler screen
- Specification grade quality
- Provided with 1/2" NPT female inlets

PART # 40451021



**ADD-ON FAUCET**

Add-on faucet extends flexibility of Pre-Rinse Assemblies by providing additional swivel spout capability. The only Add-on faucet designed specifically to permit full spout swing without interference with riser pipe. Easy installation, utilizing same water lines and controls as the Pre-Rinse. Separate valve used to control spout flow.

PART # 40451028



**DOUBLE PANTRY BASE FAUCET ASSEMBLY**

PART # 40451027



Deck Mount Pre-Rinse Valve includes wall bracket. PART # 40310013



**12" POT FILLER FAUCET**

- Operating Temperature: 40 - 180°F
  - Operating Pressure: 20 - 125psi
  - Flow Rate: 35gpm @ 60psi
  - Handle Treatment: Saniguard™
- Inorganic Antimicrobial - Lasts the life of the product
- Polished Chrome Plated Brass
  - 3/4" NPT Male Inlet
  - Single hole deck mounting
  - Full turn 3/4" Commercial Valves w/ Check Valve
  - Full Flow 1" Diameter Spout



PART # 40451035

**COMBO BASE FAUCET ASSEMBLY**

PART # 40451025



Wall Mount Pre-Rinse Assembly includes wall bracket. PART # 40310014



Economy Wall Mount Pre-Rinse with Wall Bracket and 18" Riser PART # 40451026



**WHAT IS SANIGUARD?**

SANIGUARD® plumbing and hardware products utilize silver ion technology combined with our uniquely formulated powder coating material to stop bacterial growth in its tracks. If bacteria cannot grow, it cannot survive. Many contact surfaces in the foodservice kitchen can now be used in the fight to prevent the spread of microbes.



**TOTAL MAINTENANCE SOLUTIONS**

**HOUSTON**  
800/392-5066

**ORLANDO**  
800/327-3022

**GREENVILLE**  
800/476-2212

LOOK FOR US ON THE WEB AT: [www.TMSSouth.com](http://www.TMSSouth.com)

